

Partial Discharge Monitoring

Designed for Diverse Utility and Industry Applications

Partial Discharge Monitoring

Partial discharge or PD is caused by local electrical stress in the insulation or on the surface of the insulation in electrical assets. PD testing and monitoring solutions help in detecting and assessing insulation defects which can lead to failures in electrical system.

Rugged Monitoring (RM's) PD monitoring solution with sensors, modules and software are highly sensitive to PD activity, it can effectively identify weak points in the insulation system and help in diagnosing the insulation condition of an electrical asset. Automatic warnings and alarms will immediately alert the users when pre-set PD activity thresholds have been violated.

Our precisely designed PD testing and monitoring solutions with rugged and reliable architecture can be easily customized to match customer requirements. Depending on specific operating requirements and application, we customize our solutions for:

- HV Testing
- Periodic Testing
- Continuous Online Testing

Causes for Partial Discharge Activity

Electrical assets are extensively operated under stress as they are exposed to extremely high and low temperatures, thermal, mechanical, and electrical stresses with high voltage surges. These activities consequently emerge into the degradation of insulation leading to partial discharge activity.

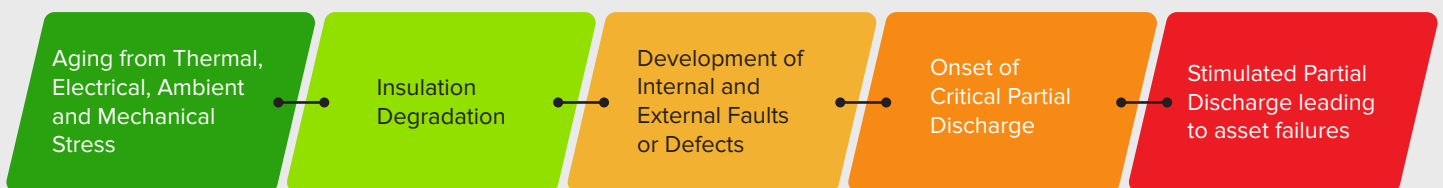

Why is RM's PD Monitoring important?

- High Sensitivity
- Accurate PD Diagnosis
- Fault Categorization
- Noise Elimination
- Rugged and Reliable Solution
- One Solution for Multiple Assets
- Integration with Enterprise Monitoring

RM's PD Solution for Transformers

Partial discharge measurements on power and distribution transformers are a proven tool to identify and locate insulation defects. The sensors installed on the transformer body, acquires High Frequency (HF) and Ultra High Frequency (UHF) PD signals and the PD monitoring system provides reliable diagnosis and recommendations.



What can be tested:



Maintank



Winding Insulation



Bushings



OLTC Insulation

RM's PD Solution for Rotating Machines

Partial discharge measurements on motors and generators can identify the weak spots in the insulation of stator windings. The PD sensors are installed on the three phases and on the neutral point to detect any PD signals PD signals of HF range. Continuous monitoring of the system when applied can determine the condition of the insulation in the rotating machines.



What can be tested:



Stator Winding insulation in Generator



Stator Winding insulation in Motor



VFD Motor

RM's PD Solution for Switchgear

Partial discharge monitoring in electrical switchgears measures electromagnetic waves propagated at various frequencies ranging from High Frequency (HF) to Ultra High Frequency (UHF) range. The monitoring system generates alarms and can be interrogated remotely at any time to detect and eliminate emerging faults.



What can be tested:



GIS



AIS



MV Switchgear Panel



Cable Termination



Isolators



Busbar



Bushing Termination



Circuit Breaker

RM's PD Solution for Cables

PD activity can be measured at critical points such as terminations and joints of the cable system. An application of High Frequency Current Transformer- Active (HFCT) along with Transient Earth Voltage (TEV) sensor can help in PD diagnostic and confirmation of internal versus external faults. Noise elimination and PD source separation algorithms are used to reliably localize harmful PD development in the cable system.



What can be tested:



Cable Terminations



Cable Joins



Insulation

Continuatiuous Online PD Monitoring System

RM's Monitoring solutions are precisely designed to monitor PD signals on different electrical assets offering a broad range of PD Monitoring Modules and Sensors.

Our On-line PD Monitoring Modules CPM601-C, HPM601-C, PD211 and PD201 along with compatible Sensors ranging from various HF to UHF ranges for MV/HV/EHV/UHV Electrical Assets and Networks, provides an early warning of incipient insulation faults, helping network operators to avoid unplanned outages.

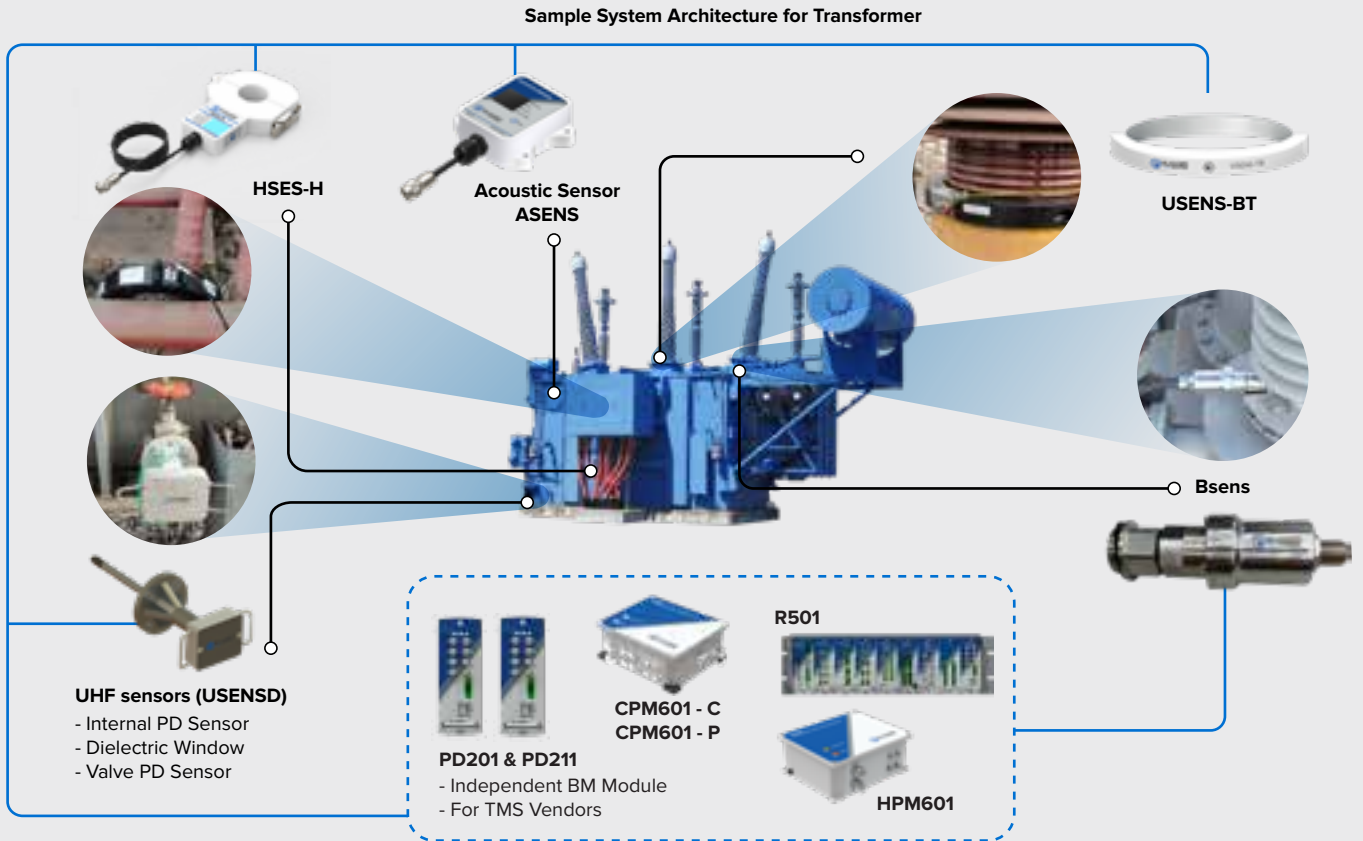

Portable PD Monitoring System

RM's Portable Monitoring modules UPM601-P, CPM601-P, HPM601-P are on-line Partial Discharge monitoring system for short-term installation. This monitor is designed to be moved around the network for short-term On-Line Partial Discharge monitoring in small time intervals. The system trends PD activity over time and detects any load variances and intermittent PD activity.

Our PD Monitors are capable of transferring the data directly to PD Connect software installed on laptop or data can be temporarily stored (optional) in the device enabling the user to record PD pulses with higher sampling rate. Thousands of pulses per second can be transferred to the laptop enabling the user to generate fast and reliable Phase Resolved Partial Discharge (PRPD) graphs. PRPD patterns help the user to identify type of PD. Monitor and Software are packed with all necessary tools that help to perform effective PD measurements.

Designed for both indoor and outdoor use, RM's Monitoring systems perform multi-channel PD and voltage data acquisition on various electrical assets under load, such as:



Power
Transformers



Rotating
Machines



AIS/GIS
Switchgear/
Switchboards



Cables and
Their Accessories

Product Selection and Configuration

DESCRIPTION		UPM601-P	UPM601-C	PD 211	CPM601-P	CPM 601-C	HPM601-P	HPM601-C	PD 201
Application for Asset Types	Transformers	✓	✓	✓	✓	✓	✓	✓	✓
	Rotating Machines	-	-	✓	✓	✓	✓	✓	✓
	Switchgear	✓	✓	✓	✓	✓	✓	✓	✓
	Power Cables	✓	✓	✓	✓	✓	✓	✓	✓
Usage	Periodic	✓	-	-	✓	-	✓	-	-
	Continuous	✓	✓	✓	✓	-	✓	-	✓
PD Measurements	HF IEC 60270	✓	✓	✓	✓	✓	✓	✓	✓
	HF and VHF	-	-	-	✓	✓	✓	✓	✓
	UHF	✓	✓	✓	✓	✓	-	-	-
	Acoustic	-	-	-	✓	✓	✓	✓	✓
Sampling Rate		250 MS/s		125 MS/s	250 MS/s				125 MS/s
Frequency	HF Channels	-			0.01 – 100 MHz				
	UHF Channels	200 – 3000 MHz					-		
No. of Channels	HF Channels	-			4	4, 8 and 12	4 or 8		
	UHF Channels	4	4 or 8	4	-				
Communication Protocols		IEC 61850, DNP 3.0, Modbus, MQTT, CANBUS							
IP Rating		IP 65		IP 4X	IP 65				IP 4X
Compatible Sensors		USENS-D, USENS-T, USENS-BT, USENS-B, USENS-C, USENS-G, USENS-W, BSENS-B, ASENS		USENS-T, USENS-BT, USENS-B, USENS-C, USENS-G, USENS-W	USENS-D, USENS-T, USENS-BT, USENS-B, USENS-C, USENS-G, USENS-W, BSENS-B, ASENS		HSENS-T, HSENS-H, HSENS-CC, BSENS-B, ASENS		USENS-T, USENS-BT, USENS-B, USENS-C, USENS-G, USENS-W

RM's range of Partial Discharge (PD) sensors can detect dangerous PD activity in Transformers, Switchgear, Rotating Machines and Cables.



HSENS-T

Sensors for Switchgear, Cable termination, Breaker, Motor



- **Transient Earth Voltage Sensor**
- **Rugged, compact design**
- **Strong magnets to attach sensor**
- **IP65 rated**
- **Transient overvoltage protection**
- **integrated inside Sensor**
- **RG223 high noise immunity cable**
- **TNC connector for reliable connection**

Hsens-T is a Transient Earth Voltage Sensor that can be used to detect external partial discharges inside metal clad switchgear or power cables termination box of rotating machines and power transformers. An application of HFCT along with TEV can help in PD diagnostic and confirmation of internal versus external PD.

Sensor is IP65 rated and features integrated transient overvoltage protection inside sensor. Transient protection will help in minimizing transients that can be expected during PD monitoring.

TEV sensor has strong magnets that help it to attach to the walls of metal clad switchgear. TEV forms a capacitive coupling with grounded metal switchgear to detect transients of external PD happening inside metal clad switchgear at termination

Rugged design, IP65 rated, overvoltage protected, PD measurement at Cables (and their accessories), Switchgears, Rotating Machines and Power Transformers

Applications

- Online periodic partial discharge monitoring
- Online PD measurement during HV AC testing
- Multiple point PD monitoring
- Cables, joints and terminations
- Rotating machines
- AIS/GIS switchgear
- Power transformers

Benefits

- Rugged sensors
- Noise immunity
- IP65 rated
- Rigorously tested
- Transient overvoltage protected
- Strong magnets to help sensor attach
- Customizable according to customer specific applications
- Suitable for Online or Online PD measurements

Technical Specifications

SENSOR	Type	Integrated magnets help it to attach to metal clad switchgear
	Frequency Response (-6dB):	1 MHz - 100 MHz
	Material	Rugged Plastic (Black), other options available
SIGNAL CABLE	Type	RG223
	Connectors	Cable Gland (Sensor End) and TNC connector (Monitor End), other options available
	Cable Length	5m as standard, other options available
IP RATING	IP65	
TEMPERATURE	Ambient	-30 °C – 70 °C
	Storage	-40 °C – 85 °C
DIMENSIONS	70mm (L) x 70mm (W) x 33 mm (H)	
CUSTOMIZATION	For any different requirement, please consult	

Ordering Code

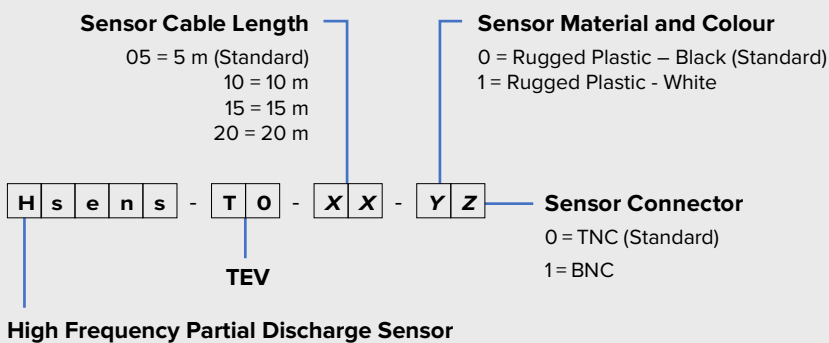

HSENS-H

Provides automated continuous partial discharge monitoring



- High Frequency Current Transformer
- Rugged, reliable design
- IP65 rated
- Split core design for easy installation
- Transient overvoltage protection integrated inside Sensor
- Different options of internal diameter dimensions
- RG223 high noise immunity cable
- TNC connector for reliable connection

Hsens-H is a High Frequency Current Transformer sensor. It is a split core and an inductive type of sensor that can be clamped around the earth (ground) shield to measure PD signals. Based on power cable termination condition, an HFCT sensor can also be clamped around cable insulation without earth shield or around the cable with earth shield looped back for the purpose of PD measurements. For HFCT clamped around the cable insulation without earth shield or cable with earth shield looped back, high current variant can be used for rated load current of cable.

Sensor is IP65 rated and features integrated transient overvoltage protection inside sensor. Transient protection will help in minimizing transients that can be expected during PD monitoring

Applications

- Online periodic partial discharge monitoring
- Online PD measurement during HV AC testing
- Multiple point PD monitoring
- Cables, joints and terminations
- Rotating machines
- AIS/GIS switchgear
- Power transformers

Benefits

- Transient overvoltage protected
- Noise immunity
- IP65 rated
- Rigorously tested
- Split core for easy installation
- Stainless steel robust latch to keep split core closed
- Customizable according to customer specific applications
- Suitable for Online or Online PD measurements

Technical Specifications

SENSOR	Type	Split core
	Frequency Response (-6dB):	100 kHz - 25 MHz
	Material	Rugged Plastic (Black), other options available
	Current Ratings	50A, other options available
MODELS	HFCT-3	220mm (L) x 118mm (W) x 33mm (H) (ID = 30mm)
	HFCT-5	220mm (L) x 163mm (W) x 28mm (H) (ID = 50mm)
	HFCT-9	265mm (L) x 200mm (W) x 38mm (H) (ID = 90mm)
	HFCT-14	330mm (L) x 275mm (W) x 38mm (H) (ID = 140mm)
SIGNAL CABLE	Connectors	RG223
	Type	Cable Gland (Sensor End) and TNC connector (Monitor End), other options available
	Cable Length	5m, other options available
IP RATING	IP65	
TEMPERATURE	Ambient	-30 °C – 70 °C
	Storage	-30 °C – 70 °C
	Customization	For any different requirement, please consult

Ordering Code

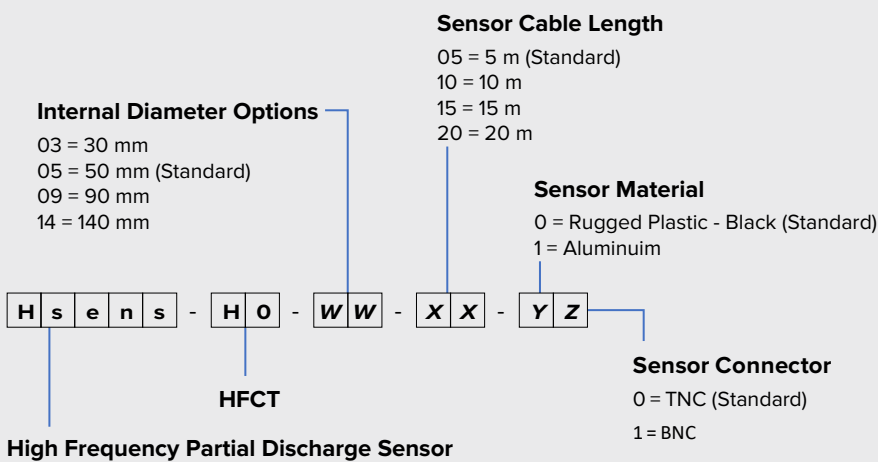

HSENS-CC

Capacitive Coupler
Partial Discharge Sensor



- **Compact Size, Highly Sensitive, Capacitive Coupler for PD Testing and Monitoring**
- **High Dielectric, Rugged, and Reliable design**
- **Built-in overvoltage (transient) protection**
- **Available for wide range of voltage levels 6kV to 45kV**
- **1pC PD Sensitivity (ASTM D1868 and IEC 60270)**
- **Suitable for extreme environment, Hazardous (ATEX) applications**
- **PD Free Sensor: No PD signals because of Sensor**

Capacitive Couplers with wide range of nominal voltage ratings are designed for Partial Discharge (PD) Testing and PD Monitoring as per IEC60270. The sensors are designed for different capacitance levels from 1nF to 80pF meeting requirements of various customers.

HSENS-CC is a Capacitive Coupler specially designed for capturing High Frequency Partial Discharge (PD) signals. The compact size and high dielectric properties of sensor makes it ideal for installation at busbar and within terminal boxes.

The sensor can be installed vertically and horizontally depending on the space limitations. The HSENS-CC sensors come with built-in overvoltage protection with different output connections (BNC/TNC). The sensors can be connected to any HF (High Frequency) PD monitoring system regardless of manufacturers.

Compact sized, Highly dielectric and accurate Partial Discharge sensor for temporary and permanent monitoring of Generators, Motors, Switchgears and Transformers.

Applications

- Continuous Online Partial Discharge Monitoring
- Periodic Partial Discharge Testing and Measurements
- High Voltage Testing during Commissioning
- Generator and Motor PD Testing and Monitoring
- MV Switchgear and Isolated Phase Bus PD Testing and Monitoring
- Transformer PD Testing and Dry Type Transformer PD Monitoring

Benefits

- Higher sensitivity 1pC increases accuracy of PD detection
- Allow PD testing and Monitoring without the need for outage
- Easy installable, and High Dielectric strength, Safest Sensors
- Shielded Sensor, Noise Immunity
- Built in overvoltage protection keeps the PDM electronics safer
- Suitable for indoor and outdoor installations
- Wider Nominal Voltage and Capacitance levels for different Applications

Technical Specifications

Capacitance	1nF, 1.2nF, 1.5nF, 2nF, 500pF, 80pF (Custom designed - Optional)
PD Sensitivity	1pC
Line Voltage Rating	6kV, 11kV, 16kV, 30kV, 45kV
Line Voltage Frequency	50Hz - 60Hz
Capacitor Type	Mica and Ceramic
Body Material	Epoxy Resin
Output Connection Type	TNC-Type connector; Customized option available
Vibration Testing	Suitable for Generator, Motor and Transformer applications
Withstand Voltages	20kV, 35kV, 70kV, 120kV
Ambient (Operating Temperature)	-40 °C to +85 °C
Storage Temperature	-40 °C to +85 °C
Operating Humidity	95% humidity at 50 °C
Dimensions (in mm)	As per Line Voltage rating; from 125(W) x 95(D) x 90(H) to 250(W) x 165(D) x 450(H)
Weight	As per Line Voltage rating; from 0.5Kg. to 5.5Kg
Install Position	Installed on the study cast aluminum enclosure and connected to the Busbar
Signal Cable	Very low attenuation Coax cable, RG58

Ordering Code

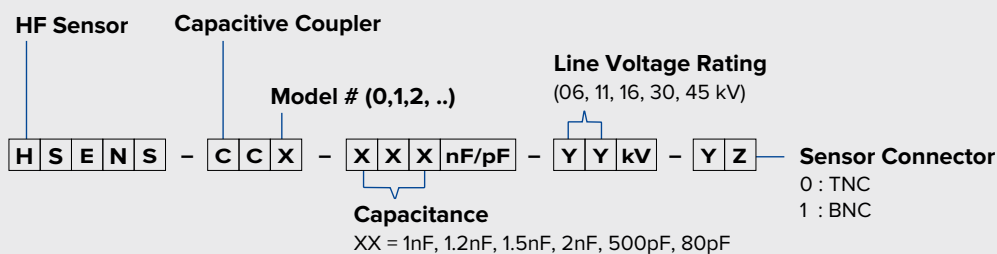

USENS-D

Sensors for Transformer and GIS UHF Partial Discharge Sensor

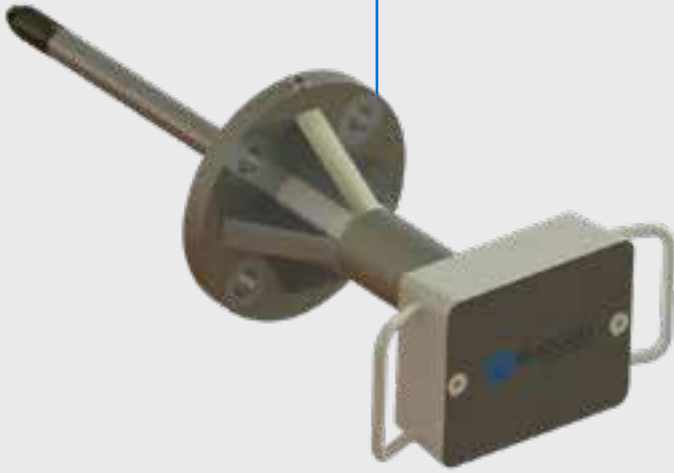

- **Wide band, Highly Sensitive, UHF PD Sensors for Transformer Drain Valves**
- **High Dielectric, Rugged, and Reliable design**
- **Built-in overvoltage (transient) protection**
- **Shielded to avoid electromagnetic interface**
- **100% Leak proof and pressure tested for 10 bar**
- **Suitable for extreme environment, Outdoor Substation**
- **Customized according to Transformer Drain Valve design**

UHF PD sensing technology has proved to be the best technology in detecting partial discharge activity inside transformer tank and real time monitoring of PD activity. Rugged Monitoring has developed the most advanced UHF PD sensor for Transformers, capable of detecting smallest PD signals.

USENS-D is an Ultra High Frequency (UHF) antenna that can detect smallest UHF frequencies emitted by the partial discharge (PD) activity. The sensors are suitable for all types of Transformers and can easily be installed on the transformer drain valves. The IP65 rated ingress protection allows sensor to be installed at Outdoor installations. Their wide band (200 - 2000 MHz) frequency response and high sensitivity (up to -90dBm) enables lower cost of PD monitoring system and higher ROI (Return on Investment).

Rugged Monitoring USENS-D is designed to fit into most of the Transformer Valves and all voltage levels. The sensors can also be customized according to Transformer Valve design and customer technical requirements. The sensors come with built-in overvoltage protection and N-type connection. The sensors can be connected to any UHF based PD monitoring system regardless of manufacturers.

Highly sensitive and accurate Partial Discharge sensor for measuring ultrahigh frequency signals emitted by partial discharge activity inside Transformers.

Applications

- Continuous Online Partial Discharge Monitoring
- Periodic Partial Discharge Testing and Measurements
- High Voltage Testing during Commissioning
- Power Transformer PD Testing and Monitoring
- Reactor PD Testing and Monitoring
- Distribution Transformer PD Testing and Monitoring

Benefits

- Higher sensitivity (-90dBm) ensure higher ROI of monitoring
- Wide frequency response, compatible with all PDM systems
- Easy installation and High Dielectric strength, Safest Sensors
- Shielded Sensor, Noise Immunity
- Built-in overvoltage protection keeps the PDM electronics safer
- IP68 protection and rugged design, suitable for outdoor installations
- Leak proof sensors enables safety and 0% oil leakage
- Customizable according to Transformer Valve design and customer requirements

Technical Specifications

UHF Frequency Response	200 - 3000 MHz
Sensitivity	up to -90 dBm
Average Effective Height over 500MHz – 1500MhHz	15 mm+
Min Effective Height over 500Mhz – 1500Mhz	6 mm+
Withstand Voltage	up to 1500 kV
Output	N-Type connector; Customized option available
Connector Circuit Impedance	50 Ω
Pressure Testing	up to 10bar
Vibration Testing	Suitable for HV - Transformer applications
Ingress Protection (IP)	IP68
Ambient (Operating Temperature)	-60 °C to +150 °C
Storage Temperature	-60 °C to +150 °C
Operating Humidity	95% humidity at 50 °C
Dimensions	Customized as per Transformer Valve design
Weight	app. 2.0 KG; Customized as per customer requirements
Install Position	Inside drain valve of Transformer
Signal Cable	Very low attenuation UHF (Coax) cable

Ordering Code

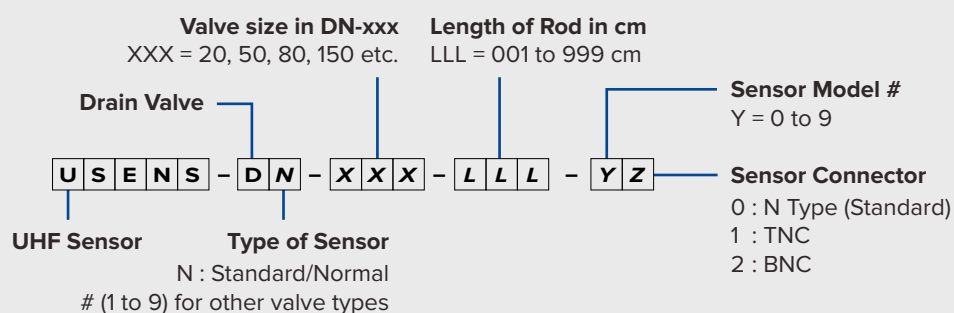

USENS-T UHF PARTIAL DISCHARGE SENSOR



- **Highly Sensitive, Wide band, UHF PD Sensors for Transformers**
- **Rugged design, 100% Leak proof**
- **Easy to Install, Integrated Transient (Over-voltage) Protection**
- **High Dielectric, shielded to avoid electromagnetic interface**
- **Suitable for extreme environment, Outdoor Substation**
- **Customized according to Transformer tank size & inspection covers**

CIGRE, TB662 and TB 343 recommends installing UHF PD sensors on transformer tank wall for Partial Discharge (PD) activity detection and real time monitoring. Rugged Monitoring has developed the most advanced UHF PD sensor for Transformers, capable of detecting smallest PD activities inside transformer tank.

USENS-T is an Ultra High Frequency (UHF) antenna that can measure Electromagnetic PD signals from the inside of transformer. The sensors are IP68 rated, easy to install on transformer tank and suitable for all types of Transformers. The sensors can easily be bolted on transformer tank (or inspection cover) directly touching the oil or with dielectric window in-between the sensor and oil. Higher sensitivity (up to -90dBm) over wide range of frequencies (200 - 3000 MHz) helps in reducing the cost of PD monitoring, hence higher ROI (Return on Investment).

Rugged Monitoring USENS-T is designed to fit on the transformer tank (or inspection cover) of different types of transformers at all voltage levels. The sensors can also be customized according to customer technical requirements. Sensor's built-in overvoltage protections and N-type connection allows them to connect with any UHF based PD monitoring system, regardless of manufacturers.

Rugged design, highly sensitive and accurate Partial Discharge sensor for detecting and monitoring partial discharge activity inside Oil Filled and Dry Type Transformers/Reactors.

Applications

- Power Transformer PD Testing and Monitoring
- Reactor PD Testing and Monitoring
- Distribution Transformer PD Testing and Monitoring
- Continuous Online Partial Discharge Monitoring
- Periodic Partial Discharge Testing and Measurements
- High Voltage Testing during Commissioning

Benefits

- Higher sensitivity (-90dBm); detect even smallest PD activity
- Wider frequency response, compatible with all PDM systems
- High Dielectric Strength, Safest installation and operation
- Shielded Sensor, Lower Signal-to-Noise Ratio
- Integrated overvoltage protection, for the safety of PDM electronics
- Rugged design, IP68 Protection, Longer life
- 100% leak proof sensor
- Customizable according to the customer requirements

Technical Specifications

UHF Frequency Response	200 - 3000 MHz
Sensitivity	up to -90 dBm
Average Effective Height over 500MHz – 1500MhHz	25 mm+
Min. Effective Height over 500Mhz – 1500Mhz	6 mm+
Withstand Voltage	up to 1500 kV
Output	N-Type connector; Customized option available
Connector Circuit Impedance	50 Ω
Oil Pressure	up to 10bar
Vacuum Tightness	< 0.10 mbar, Leakage rate < 0.0001 mbar/sec
Vibration Testing	Suitable for HV - GIS and Transformer applications
Ingress Protection (IP)	IP-68
Ambient (Operating Temperature)	-60 °C to +150 °C
Storage Temperature	-60 °C to +150 °C
Operating Humidity	95% humidity at 50 °C
Dimensions	Customized as per Transformer Flange Design
Weight	app. 1.5 KG; Customized as per customer requirements / Transformer Design
Install Position	Transformer Tank, Inspection Cover, Transformer Dielectric Window
Signal Cable	Very low attenuation UHF (Coax) cable

Ordering Code

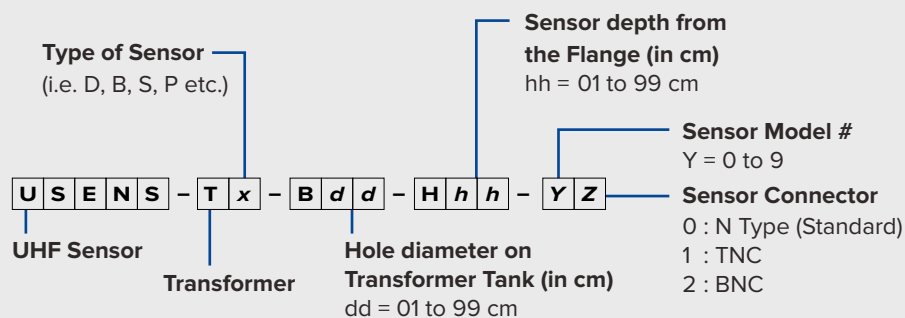

USENS-BT BUSHING PARTIAL DISCHARGE SENSOR



- Bushing PD sensor with wider frequency
- Response range
- HF and UHF frequency response
- Rugged, reliable design
- IP65 rated
- Transient overvoltage protection integrated
- Easy to Install
- Different options of internal diameter dimensions

Usens-BT is suitable for High Frequency (HF) and Ultra High Frequency (UHF) PD signals. The Sensor is designed to be installed on transformer bushing trunk.

Sensor is IP65 rated and features integrated transient overvoltage protection inside sensor. Transient protection will help in minimizing transients that can be expected during PD monitoring.

Rugged and reliable design, IP65 rated, overvoltage protected, PD measurement at Transformer Bushings.

Applications

- Online periodic partial discharge monitoring
- Online PD measurement during HV AC testing
- Multiple point PD monitoring

Benefits

- Transient overvoltage protected
- Noise immunity
- IP65 rated
- Rigorously tested

Technical Specifications

Frequency Response	30MHz - 1500MHz
Sensitivity	up to -70 dBm
Withstand Voltage	up to 1000 kV
Output	N-Type connector; Customized option available
Connector Circuit Impedance	50 Ω
Vibration Testing	Suitable for installation on Transformer Bushings
Ingress Protection (IP)	IP-65
Ambient (Operating Temperature)	-60 °C to +100 °C
Storage Temperature	-60 °C to +100 °C
Operating Humidity	95% humidity at 50 °C
Dimensions	Customized as per Bushing Size
Weight	Customized as per Bushing Size
Install Position	Around Bushing Trunk
Signal Cable	Very low attenuation UHF (Coax) cable

Ordering Code

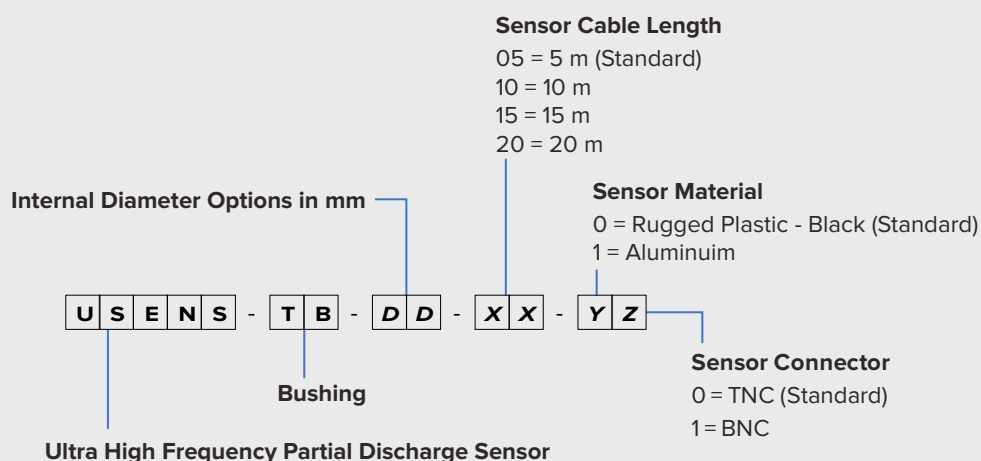

USENS-B UHF PARTIAL DISCHARGE SENSOR



- Rugged Design, Easy installation on the GIS Barrier
- High Dielectric and Built-in overvoltage protection
- Highly Sensitivity, and Wide band UHF PD Sensor
- Shielded to avoid electromagnetic interface
- IP66 rated, suitable for outdoor substation environment
- Customized to fit any size of barrier openings

It is a well proven fact that Partial Discharge (PD) monitoring systems have saved many catastrophic failures into switchgears and GIS globally. Most of the new GIS installations are now coming up with pre-installed UHF PD sensors. For older GIS substations, with opening on the barrier's, Rugged Monitoring has developed the most sensitive UHF PD sensor.

USENS-B is an Ultra High Frequency (UHF) antenna that can detect smallest UHF frequencies emitted by the partial discharge (PD) activity. The sensors are customized to fit on different kind of GIS barrier openings. The sensors can easily be placed on the Barrier opening and then fixed with the belt coverage for PD monitoring.

Rugged Monitoring's USENS-B can be customized to fit into any size of GIS Barrier opening with higher response. The sensors come with built-in overvoltage protection and N-type connection. The sensors can relate to any UHF based PD monitoring systems regardless of manufacturers.

High sensitivity, designed for reliability, Customised UHF technology based Partial Discharge sensors for GIS barrier openings.

Applications

- Periodic Partial Discharge Testing and Measurements
- Continuous Online Partial Discharge Monitoring
- High Voltage Testing after maintenance/ Overhaul
- GIS/ GIL PD Testing and Monitoring
- GIT (Gas Insulated Transformers) PD Testing & Monitoring
- Circuit Breaker PD Testing and Monitoring

Benefits

- Higher sensitivity (-70dBm) ensure higher ROI of monitoring
- Wide frequency response, compatible with all PDM systems
- Easy installable, and High Dielectric strength, Safest Sensors
- Shielded Sensor, Noise Immunity
- Built-in overvoltage protection keeps the PDM electronics safer
- IP65 protection and rugged design, suitable for outdoor installations
- Leak proof sensors enables safety and 0% SF6 leakage
- Customized according to Barrier Opening and customer requirements

Technical Specifications

UHF Frequency Response	200 - 3000 MHz
Sensitivity	up to -70 dBm
Average Effective Height over 500MHz – 1500MHz	06 mm+
Withstand Voltage	up to 1500 kV
Output	N-Type connector; Customized option available
Connector Circuit Impedance	50 Ω
Vibration Testing	Suitable for HV - GIS and Transformer applications
Ingress Protection (IP)	IP-66
Ambient (Operating Temperature)	-60 °C to +100 °C
Storage Temperature	-60 °C to +100 °C
Operating Humidity	95% humidity at 50 °C
Dimensions	Customized as per different GIS Barrier Types and Openings
Weight	Customized as per different GIS Barrier Types and Openings
Install Position	GIS / GIT / GIL Barrier Openings
Signal Cable	Very low attenuation UHF (Coax) cable

Ordering Code

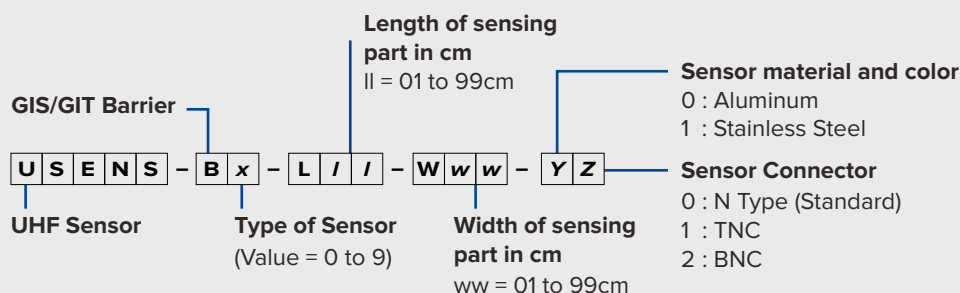

USENS-C PARTIAL DISCHARGE SENSOR



- Rugged, reliable design
- IP65 rated
- Transient overvoltage protection
- Easy to Install
- Different options of internal diameter dimensions

USENS-C is Ultra High Frequency (UHF) PD sensor for Power cables, Switchgears. The sensor can be installed directly on the power cable and switchgears.

The IP65 rated Sensor has integrated transient overvoltage protection inside. Transient protection will help in minimizing transients that can be expected during PD monitoring.

Ultra High Frequency PD sensors for Cables and switchgears

Applications

- Online periodic partial discharge monitoring
- Online PD measurement during HV AC testing
- Multiple point PD monitoring

Benefits

- Transient overvoltage protected
- Noise immunity
- IP65 rated
- Rigorously tested

Ordering Code

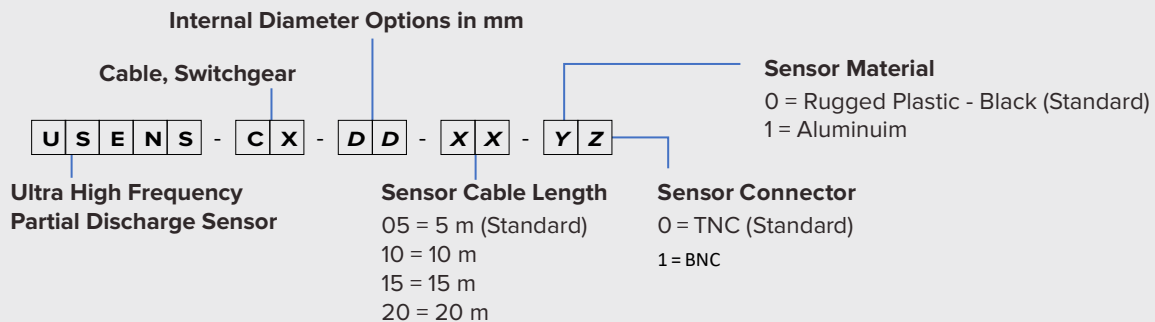

Technical Specifications

Frequency Response	30MHz - 1GHz
Sensitivity	up to -70 dBm
Withstand Voltage	up to 1500 kV
Output	N-Type connector; Customized option available
Connector Circuit Impedance	50Ω
Vibration Testing	Suitable for HV - GIS and Transformer applications
Ingress Protection (IP)	IP-65
Ambient (Operating Temperature)	-60 °C to +100 °C
Storage Temperature	-60 °C to +100 °C
Operating Humidity	95% humidity at 50 °C
Dimensions	Customized as per customer requirements
Weight	Customized as per customer requirements
Install Position	Power Cables, Terminations, Switchgears, Rotating Machines
Signal Cable	Very low attenuation UHF (Coax) cable

USENS-G UHF PARTIAL DISCHARGE SENSOR



- **Wide band, Highly Sensitive, UHF PD Sensors for GIS**
- **High Dielectric, Rugged, and Reliable design**
- **Built-in overvoltage (transient) protection**
- **Shielded to avoid electromagnetic interface**
- **100% Leak proof and pressure tested for 10 bar (Helium)**
- **Suitable for extreme environment, Outdoor Substation**
- **Customized according to GIS flange design & voltage level**

Monitoring partial discharge (PD) activity into the GIS (Gas Insulated Switchgear) is very important in determining the condition of the GIS and decide on condition-based maintenance. All major power utilities and industrial customers are demanding for built-in PD sensors in their new GIS installations. Rugged Monitoring has developed the most advanced UHF PD sensor for GIS, capable of detecting smallest PD signals.

USENS-G is an Ultra High Frequency (UHF) antenna that can detect smallest UHF frequencies emitted by the partial discharge (PD) activity. The sensors are suitable for all types of GIS, and easy installation on the GIS flange. The sensors can easily be bolted on GIS flange. The IP65 rated ingress protection allows sensor to be installed at Outdoor GIS installations. Their wide band (200 - 3000 MHz) frequency response and high sensitivity (up to -90dBm) enables lower cost of PD monitoring system and higher ROI (Return on Investment).

Rugged Monitoring USENS-G is designed to fit into most of the GIS at all voltage levels. The sensors can also be customized according to GIS design and customer technical requirements. The sensors come with built-in overvoltage protections and N-type connection. The sensors can relate to any UHF based PD monitoring system regardless of manufacturers.

Highly sensitive and accurate Partial Discharge sensor for measuring ultrahigh frequency signals emitted by partial discharge activity inside Gas Insulated Switchgears (GIS).

Applications

- Continuous Online Partial Discharge Monitoring
- Periodic Partial Discharge Testing and Measurements
- High Voltage Testing during Commissioning
- GIS PD Testing and Monitoring
- MV Switchgear PD Testing and Monitoring
- Circuit Breaker PD Testing and Monitoring

Benefits

- Higher sensitivity (-90dBm) ensure higher ROI of monitoring
- Wide frequency response, compatible with all PDM systems
- Easy installable, and High Dielectric strength, Safest Sensors
- Shielded Sensor, Noise Immunity
- Built-in overvoltage protection keeps the PDM electronics safer
- IP65 protection and rugged design, suitable for outdoor installations
- Leak proof sensors enables safety and 0% SF6 leakage
- Customizable according to GIS design and customer requirements

Technical Specifications

UHF Frequency Response	200 - 3000 MHz
Sensitivity	up to -90 dBm
Average Effective Height over 500MHz – 1500MhHz	25mm+
Min. Effective Height over 500Mhz – 1500Mhz	16mm+
Withstand Voltage	up to 1500 kV
Output	N-Type connector; Customized option available
Connector Circuit Impedance	50 Ω
Pressure Testing	up to 10bar (with Helium Gas)
Vibration Testing	Suitable for HV - GIS and Transformer applications
Ingress Protection (IP)	IP-65
Ambient (Operating Temperature)	-60 °C to +100 °C
Storage Temperature	-60 °C to +100 °C
Operating Humidity	95% humidity at 50 °C
Dimensions	Customized as per GIS design
Weight	app. 2.0 KG; Customized as per customer requirements
Install Position	GIS Enclosure
Signal Cable	Very low attenuation UHF (Coax) cable

Ordering Code

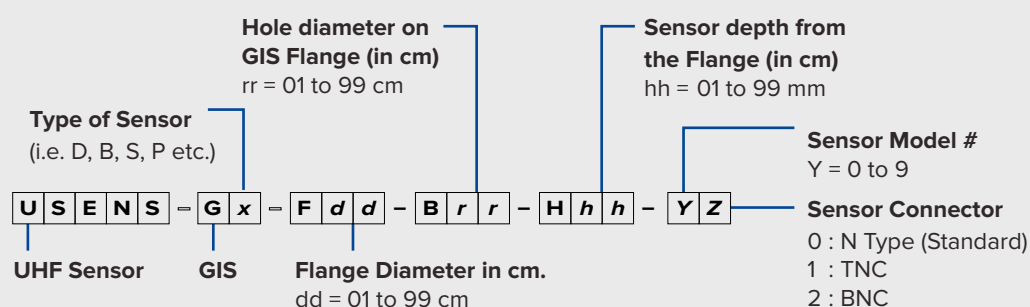

USENS-W UHF PARTIAL DISCHARGE SENSOR



- Wide band, Highly Sensitive, UHF PD Sensors for GIS
- High Dielectric, Rugged, and Reliable design
- Built-in overvoltage (transient) protection
- Shielded to avoid electromagnetic interface
- IP65 rated, easy installable
- Suitable for extreme environment,
- -60 0C to +100 0C ambient temperature
- Customized according to GIS flange design and voltage level

Monitoring partial discharge (PD) activity into the GIS (Gas Insulated Switchgear) is very important in determining the condition of the GIS and decide on condition-based maintenance. All major power utilities and industrial customers are demanding for built-in PD sensors in their new GIS installations. Rugged Monitoring has developed the most advanced UHF PD sensor for GIS, capable of detecting smallest PD signals.

USENS-W is an Ultra High Frequency (UHF) antenna that is capable of detecting smallest UHF frequencies emitted by the partial discharge (PD) activity. The sensors are suitable for all types of GIS, and easy installation on the GIS flange. The sensors can easily be bolted on GIS flange. The IP65 rated ingress protection allows sensor to be installed at Outdoor GIS installations. Their wide band (200 - 3000 MHz) frequency response and high sensitivity (up to -90dBm) enables lower cost of PD monitoring system and higher ROI (Return on Investment).

Rugged Monitoring USENS-W is designed to fit into most of the GIS at all voltage levels. The sensors can also be customized according to GIS design and customer technical requirements. The sensors come with built-in overvoltage protection and N-type connection. The sensors can be connected with any UHF based PD monitoring system regardless of manufacturers.

Highly sensitive and accurate Partial Discharge sensor for measuring ultra-high frequency signals emitted by partial discharge activity inside Gas Insulated Switchgears (GIS).

Applications

- Continuous Online Partial Discharge Monitoring
- Periodic Partial Discharge Testing and Measurements
- High Voltage Testing during Commissioning
- GIS PD Testing and Monitoring
- MV Switchgear PD Testing and Monitoring
- Circuit Breaker PD Testing and Monitoring

Benefits

- Higher sensitivity (-90dBm) ensure higher ROI of monitoring
- Wide frequency response, compatible with all PDM systems
- Easy installable, and High Dielectric strength, Safest Sensors
- Shielded Sensor, Noise Immunity
- Built-in overvoltage protection keeps the PDM electronics safer
- IP65 protection and rugged design, suitable for outdoor installations
- Leak proof sensors enables safety and 0% SF6 leakage
- Customizable according to GIS design and customer requirements

Technical Specifications

UHF Frequency Response	200 - 3000 MHz
Sensitivity	up to -90 dBm
Average Effective Height over 500MHz – 1500MhHz	25mm+
Min. Effective Height over 500Mhz – 1500Mhz	16mm+
Withstand Voltage	up to 1500 kV
Output	N-Type connector; Customized option available
Connector Circuit Impedance	50 Ω
Pressure Testing	up to 10bar (with Helium Gas)
Vibration Testing	Suitable for HV - GIS and Transformer applications
Ingress Protection (IP)	IP-65
Ambient (Operating Temperature)	-60 °C to +100 °C
Storage Temperature	-60 °C to +100 °C
Operating Humidity	95% humidity at 50 °C
Dimensions	250 x 190 x 100 mm; Customized as per GIS design
Weight	app. 2.0 KG; Customized as per customer requirements
Install Position	GIS Enclosure
Signal Cable	Very low attenuation UHF (Coax) cable

Ordering Code

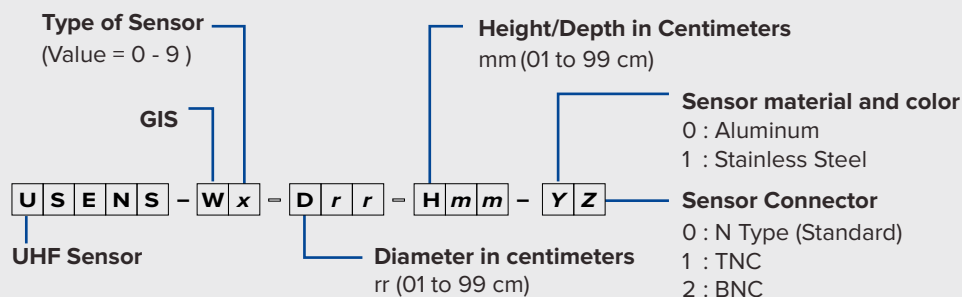

BSENS Bushing Sensor for Improved Transformer Reliability to Avoid Bushing Failure



Bushing failures can be caused by transient overvoltage's, temperature fluctuations, as well as by the ingress of moisture, which can quickly lead to failure of bushing insulation or even to a major transformer failure.

Our BSENS continually perform online condition monitoring of transformer bushings through regular time-based diagnostics. Bushing adaptors are installed at the bushing test tap or voltage tap. Being a function of phase ground voltage and impedance of the bushing insulation, leakage current passes through the tap adaptors flowing to ground through capacitance, any imbalance in the impedance of the insulation will lead to variation in leakage current.

The measured leakage current from BSENS provides following outputs:

- Capacitance
- Tan δ or Dissipation Factor
- Partial Discharge Signals

Bushing Sensors for Tan δ and Capacitance monitoring are based on measuring Leakage Current in the range of 1mA to 200mA which also additionally provides HF signals between 100 kHz – 25 MHz for PD monitoring.

We at Rugged Monitoring have 45+ different bushing tap adaptors designed to cover most of the bushings aiding in faster system commissioning. Our standard sensors are designed for bushings with rated voltage of upto 1500 kV.

Benefits

- Easy Installation and Commissioning
- Flexible configuration options to meet customer expectations
- Generates highly accurate data
- Early incipient fault detection ensures reliable operation and reduces supply outages

Applications



Condensing/ capacitive type bushings



Transformer Bushings



Breaker Bushings



Features

- Reliable and robust product
- Measures leakage currents of fundamental harmonics
- Variants are available for monitoring up to 6 bushings on three phase transformers
- It measures High Frequency PD signals
- Based on industry standard method
- Most accurate condition analysis
- Custom designed for various bushing taps

Technical Specifications

ELECTRICAL SPECIFICATIONS	Transient Voltage Protection	Up to 1500 KV Bushings
	Bushing Tap Earthing Protection	Double Protection against any loss to grounding connection
	Sensor Output	Leakage Current = 1mA to 200mA Partial Discharge: 100 kHz to 25 MHz
	Recommended Cable	RG223 or RG213
	Measured Parameters	Leakage Current and Partial Discharge
MECHANICAL SPECIFICATIONS	Custom designed for various bushing taps	
ENVIRONMENTAL SPECIFICATIONS	Operating Temperature	-60°C to +95°C
	Storage Temperature	-40°C to +85°C
	Humidity	95% Relative Humidity
	IP rating	IP 66 (Protection against moisture ingress)

Ordering Code

BUSHING SENSOR- LEAKAGE CURRENT

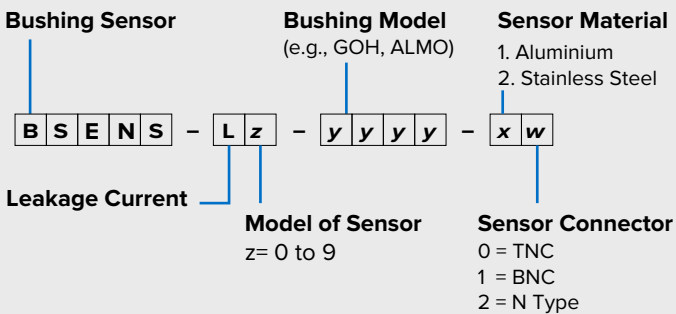

BUSHING SENSOR- PARTIAL DISCHARGE

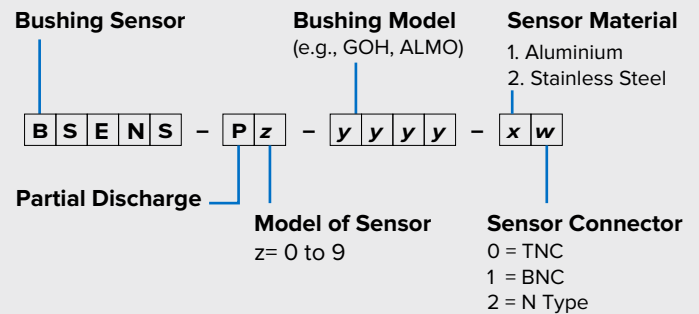

ASENS

Modular design for partial discharge monitoring in electrical assets



Partial Discharge activity is an indicator of increasing defects in insulation. PD is a discharge or spark that partially bridges the gap between conducting electrodes. The discharge may be in oil filled equipment or in a gas filled environment.

RM's ASENS with acquisition system is specifically designed to detect partial discharge using portable measurement/ continuous monitoring methods and is also capable to locate PD position by studying the PD amplitude and phase delay of the acoustic waves propagating through the discharge activity. The location of the PD can be estimated by measuring the time of arrival of the acoustic wave, and PD localization is

ascertained by using sensors at multiple locations of assets. This makes acoustic emission sensing a preferable measuring tool in real time PD signal detection.

RM's advanced acoustic measurement has an additional advantage of possessing better- signal to noise ratio for real-time applications. To avoid the damage to high voltage equipment, detecting and locating PD is crucial both in industries and utilities. Acoustic waves are measured by ASENS, and the AE System will identify the real PD and their location based on ML/Time Difference of Arrival (TDOA) algorithm with the highest percentage of location accuracy to fault location.

The highly sensitive ASENS can be used for measurement of PD on Transformer Tanks, GIS, Reactors, Large Pressure Vessels, and for Leak Detection. Depending on the application and environment the sensors are available with three different resonant frequencies of 40 KHz, 80 KHz and 150 KHz.

Benefits

- PD localization with multiple sensors
- High noise immunity for online partial discharge detection
- Integrated amplifier for better SNR
- Significant time saving through fast localization of the fault
- Quick and easy application
- Good return on investment

Features

- Built in pre-amplifier
- Narrow band resonant sensor with highest signal to noise ratio
- Simple and rugged sensor
- Easy to use, light weight
- Plug and play connections
- Highly sensitive

Applications



Oil Filled Reactors



Oil Filled Transformers



Gas Insulated Switchgears
and Gas Insulated Lines

Technical Specifications

Specifications	Gas Insulated Switchgear (GIS)	Oil Filled Transformer/ Reactors	Oil Filled Transformers
Resonant Frequency	50 KHz	80 KHz	150 KHz
Frequency Range	15 KHz - 70 KHz	20 KHz - 180 KHz	60 KHz - 400 KHz
Sensitivity Peak	>115 dB	>70 dB	>115 dB
Built in Pre-amplifier	40 dB 28 V	-	40 dB 28 V
Size mm	Φ30 x 57	Φ19 x 19.5	Φ30 x 36.5
Applicable Temperature °C	-20 to 50°C	-20 to 80°C	-20 to 50°C
Housing Material	SUS-504	SUS-304	SUS-304
Receiving Surface Material	Ceramic	Ceramic	Ceramic
Protection Grade	IP62	IP62	IP62
Connector Type	BNC	M5	BNC
Connector Position	Side Face	Side Face	Side Face
Product Features	Built in Pre-Amplifier	Low Frequency	Built in Pre-Amplifier

TEV Sensor

Transient Earth Voltage Sensor - Active

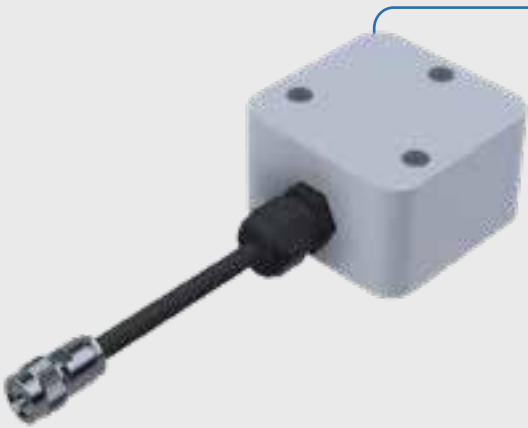

Rugged design, designed for reliability, PD measurement at cable terminations and joints

- Rugged, Compact Design
- Strong magnets to attach sensor
- Rugged and robust material used
- Multicore high noise immunity cable
- System self test capability

A TEV sensor can be used to detect external partial discharges inside metalclad switchgear. An application of HFCT along with TEV can help in PD diagnostic and confirmation of internal versus external PD.

TEV sensor has strong magnets that help it to attach to the walls of metalclad switchgear. TEV forms a capacitive coupling with grounded metal switchgear in order to detect transients of external PD happening inside metalclad switchgear at termination

Active type sensor has also facility to inject self test pulse and being detected by same TEV again. This is compatible with measurement system. It helps to confirm system health from Sensor to Server.

Applications

- Online periodic partial discharge monitoring
- Online PD measurement during HV AC Resonant testing
- Multiple point PD monitoring
- Cable joints and terminations
- Rotating machines cables termination boxes
- Cables connected to AIS/GIS switchgear
- Cables connected to Transformers

Benefits

- Rugged sensors
- Noise immunity
- Robust packaging
- Rigorously tested
- Strong magnets to help sensor attach
- Customizable according to customer specific applications
- Suitable for Online or Online PD measurements
- System self test capability

Technical Specifications

SENSOR	Type	Integrated magnets help it to attach to metalclad switchgear
	Frequency Response	1 MHz - 50 MHz
	Material	Acetal
SELF TEST CAPABILITY	Active Sensor	Yes. Self test pulses are injected into the sensor and acquired to confirm sensor functionality
	Dimensions	70mm (W) x 70mm (L) x 37 mm (H)
CONNECTION CABLE	Type	Cat6 (Active type)
	Connectors	Cable Gland (Sensor End) and Multi-pin connector (Monitor End)
	Cable Length	10m as standard
	Temperature	-40C - 80C (Operating) -40C - 90C (Storage)
	Customisation	For any different requirement, please consult

HFCTA High Frequency Current Transformer-Active

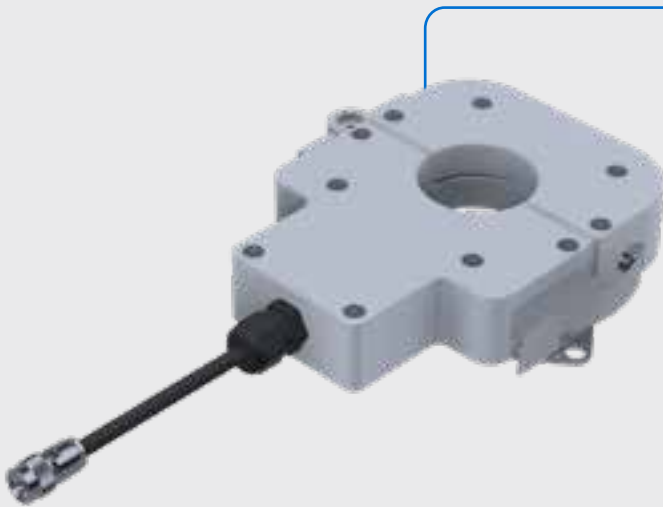

Rugged design, designed for reliability, PD measurement at cable terminations and joints

- Rugged, Compact Design
- Split core design for easy installation
- Rugged and robust material used
- Different options of internal diameter dimensions
- Multicore high noise immunity cable
- Multi-pin high frequency connector for reliable connection
- System self test capability

An HFCT sensor is a split core and an inductive type sensor that can be clamped around the cable earth shield to measure PD signals. Based on the termination type, an HFCT sensor can also be clamped around cable insulation without earth shield or around the cable with earth shield looped back.

For HFCT clamped around the cable insulation or cable with earth shield looped back, high current variant can be used Active-Type of HFCT sensor has facility to inject self test pulse into the cable and being detected by same HFCT again. This functionality is compatible with portable system. This helps system health check from Sensor to Server.

Applications

- Online periodic partial discharge monitoring
- Online PD measurement during HV AC Resonant testing
- Multiple point PD monitoring
- Cable joints and terminations
- Rotating machines cables termination boxes
- Cables connected to AIS/GIS switchgear
- Cables connected to Transformers

Benefits

- Rugged sensors
- Noise immunity
- Robust packaging
- Rigorously tested
- Split core for easy installation
- Stainless steel robust latch to keep split core closed
- System self test capability
- Suitable for Online or Offline PD measurements

Technical Specifications

SENSOR	Type	Split core
	Frequency Response	100 kHz - 25 MHz
	Material	Acetal, Aluminum (optional)
	Current Ratings	50A for standard Up to 1000A for high current variant
SELF TEST	Active Sensor	Yes. Self test pulses are injected into the sensor and acquired to confirm sensor functionality
MODELS	HFCT-3	170mm (L) x 80mm (W) x 35mm (H) (ID = 30mm)
	HFCT-5	170mm (L) x 125mm (W) x 30mm (H) (ID = 50mm)
	HFCT-9	215mm (L) x 160mm (W) x 40mm (H) (ID = 90mm)
	HFCT-14	280mm (L) x 230mm (W) x 40mm (H) (ID = 140mm)
CONNECTION CABLE	Type	Cat6 (Active type)
	Connectors	Cable Gland (Sensor End) and Multi-pin connector (Monitor End)
	Cable Length	10m as standard
	Temperature	-40C – 70C (Operating) -40C - 90C (Storage)
	Customisation	For any different requirement, please consult

H2SENS



Hydrogen sensors for transformer dissolved gas monitoring using our proven DGA platform

Advance hydrogen sensing technology using palladium-nickel alloys with proprietary materials coating to protect the sensor, enabling it to measure hydrogen in oil or gas phase of power transformers and ancillary equipment.

This solid-state sensing element is hydrogen specific, inert to other transformer gases and can be immersed directly in the transformer oil during normal operation to measure hydrogen levels continuously. H2SENS platform has no consumable components or any degradation of the sensor, does not require carrier or calibration gases to maintain accuracy and has a theoretically unlimited useful life.

Technical Specifications

Parameter	Oil Phase	Gas Phase
Measurement Accuracy Range	25 - 5,000 ppm	500 - 100,000 ppm
Accuracy ¹	20% of reading or 25 ppm [†]	20% of reading or 500 ppm
Repeatability ²	10% of reading or 15 ppm [†]	10% of reading or 300 ppm
Response Time	< 60 minutes	< 60 minutes
Operating Temperature (Ambient)	40°C to +70°C	-40°C to +70°C
Storage Temperature	-40°C to +85°C	40°C to +85°C
Oil Temperature Range ³	-40°C to +105°C	n/a
Data Log Storage	1 Year	1 Year
Cross-sensitivity to H ₂ O, CO ₂ , C ₂ H ₂ , C ₂ H ₄ , CO, etc.	<1%	<1%
Serial Communications	RS485, MODBUS RTU	RS485, MODBUS RTU
Power Supply	9-48 VDC, 10 Watt	9-48 VDC, 10 Watt

[†] whichever is greater

Physical Specifications

Wetted Materials

316SS, 40% mineral filled Nylon, polyimide, glass

Sealing

Hermetic glass-to-metal feedthrough, Buna-N gaskets

Housing

Hard Anodized 6061 Aluminum

Humidity and Corrosion Resistance

Class C5M Marine rated; salt-water condensing (IEC 60068-2-11 & DIN EN ISO 12944)

Ratings

CE Mark (IEC 61000)
 ROHS 2011/65/EU compliant
 EMC/RFI and Other Electrical Certification

- IEC 55022 IFCC Part 15
- IEC 55024
- IEC 55011
- IEC 61000-4-2 through 61000-4-6, and 61000-4-8
- IEC 61010-1
- IEC 60255-5
- IEC 61326

Ingress Protection

IP68; 25 feet water for 14 days (IEC 60529)

Vibration

3-axis Sinusoidal, Wideband and Random [Simulated Long-Life] (IEC 60068-2-6 table C.2, IEC 60068-2-64 paragraph A.2, category no. 2, IEC 61373: 2010 Cat 1B section 9)
 Shock: 30g, shock duration 18ms (IEC 60068-2-27)

DIMENSIONS (inches)

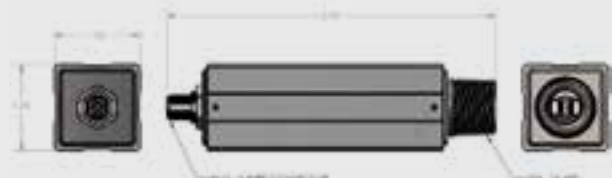

H2 Sensor Key Features and Benefit

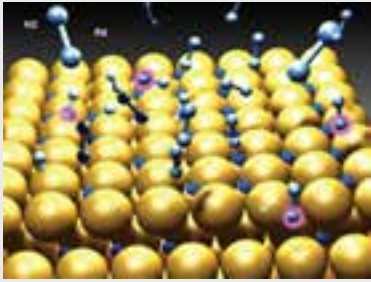

H2SENS sensor is based on many years of research, experience and commercial success in various industries, including petroleum refineries, chemical production, nuclear power plants and fuel cells. H2SENS sensor is developed specifically for monitoring hydrogen in electric power transformers and other oil filled apparatus.

H2SENS sensors can be retrofitted onto active transformers without having to de-energize them. Unlike other technologies, H2SENS sensor technology does not suffer from signal saturation at high hydrogen concentrations. The sensor continuously measures oil temperature and provides an oil-temperature corrected hydrogen signal that can be used to activate relays and provide early warnings of a transformer failure.

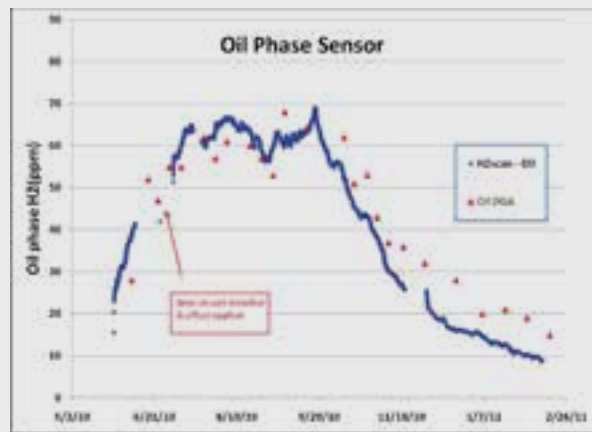

- Low cost solution for key incipient fault marker that is easy to install and maintain
- Operates immersed directly in transformer oil or headspace
- Continuous hydrogen monitoring reveals potential faults to ensure timely action and avoid downtime
- Reduced dependence on costly oil sample based DGA diagnostics
- No membrane, consumables, moving parts or reference gas

H2 Sensor Performance

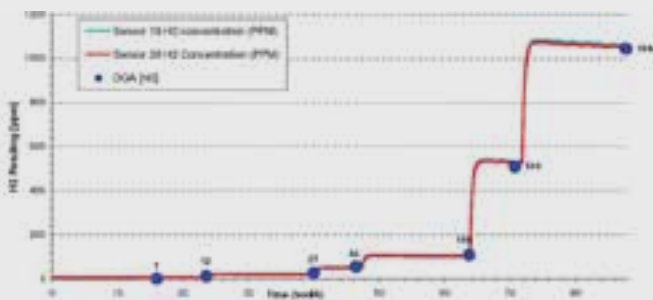

Sensor matches DGA readings in Oil Phase

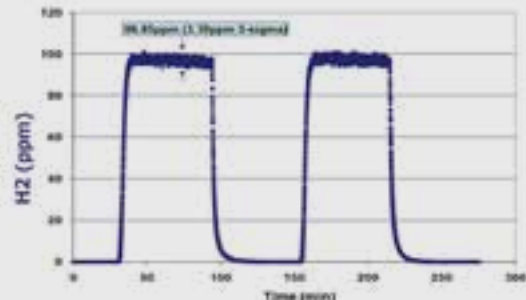

Sensor performance in Gas Phase

H2 Sensor for Transformers and Other Oil Filled Asset

May be installed on New and Retrofit Applications

- Any class of oil filled transformer (Transmission /Distribution /Commercial /Industrial)
- Instrument Transformers
- Load Tap Changers and other oil-filled assets



Transformer Installation

SYNC-EF Synchronization Sensor



Rugged design, designed for reliability, synchronization.

- Rugged, compact design
- Safe and reliable operation
- Captures the electric field of high voltage asset near termination
- Used when acquisition system (PD Monitor) is energized with external supply which is not in synchronization with device under test
- No outage required for installation
- IP65 rated

A synchronization signal is required during Partial Discharge measurement in power cables and other high voltage assets. SYNC-EF utilises the benefits of Electric Field to capture the field generated AC voltage in a power cable or low voltage cables. This sensor is well suited to the application where AC mains synchronised with cable under test is not available and PD Monitor is being powered by using external AC generator or UPS.

Applications

- Online periodic partial discharge monitoring
- Synchronization of PD measurements
- Multiple point PD monitoring
- Cables and their accessories
- Rotating machines
- AIS/GIS switchgear/switchboards
- Power transformers

Benefits

- No direct connection to any live conductor
- Can be used temporarily or mounted permanently
- Enhanced noise rejection
- Rugged and reliable design

Technical Specifications

SENSOR	Technology	Electric Field
	Frequency	50 Hz / 60 Hz
	Material	Anodized Aluminum
	Cable	10m shielded cable from Sensor to PD Monitor
	Output	Up to 10m shielded cable with 8 pin connector on other end Compatible with Rugged Monitoring PD Monitors Compatible
IP RATING	IP65	
TEMPERATURE RATING	Ambient	-25C - 70C
	Storage	-40C - 85C
POWER RATING	Input Power	1W

Ordering Code

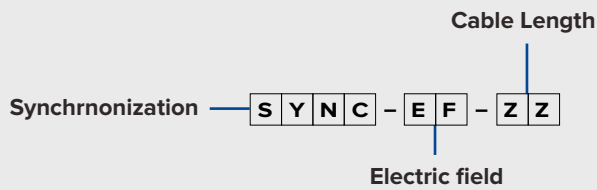

SYNC-MF Synchronization Sensor



Rugged design, designed for reliability, Synchronzation.

A synchronzation signal is required during Partial Discharge measurement in power cables and other high voltage assets. SYNC-MF utilises the benefits of Rogowski Coil technology to capture the magnetic field generated by load or circulating currents in a power cable or ground loop. This sensor is well suited to the application where PD monitor is powered up using external generator, renewable energy or UPS and is not synchronised with asset under test.

Applications

- Online periodic partial discharge monitoring
- Synchronzation of PD measurements
- Multiple point PD monitoring
- Cables and their accessories
- Rotating machines
- AIS/GIS switchgear/switchboards
- Power transformers

Features

- Rugged, compact design
- Safe and reliable operation
- Captures the magnetic field of conductor load current or sheath circulating current to generate synchronzation pulses for PD Monitor
- Used when acquisition system (PD Monitor) is energized with external supply which is not in synchronzation with device under test
- No outage required for installation
- IP65 rated

Benefits

- No direct connection to any live conductor
- Can be used temporarily or mounted permanently
- Enhanced noise rejection
- Rugged and reliable design
- Software packed with useful tools for reliable and interactive
- PD measurements
- Robust recording and analytics
- Customizable according to customer specific applications
- Suitable for Online or Offline PD measurements

Technical Specifications

SENSOR	Technology	Rogowski Coil
	Frequency	10 Hz - 1 MHz
	Current	1A - 2000A
	Material	Thermoplastic Rubber
	Dimensions Sensor	150mm Internal Diameter
	Dimensions Cable	10m shielded cable from Sensor to Junction Box
TERMINATION	Connectors	Cable Glands
	Material	Anodized Aluminum
	Output	1m shielded cable with 8 pin connector on other end Compatible with Rugged Monitoring PD Montors 3.3V synchronization pulses for load or circulating current of 1A and above
IP RATING	IP65	
TEMPERATURE RATING	Ambient	-25C - 70C
	Storage	-40C - 85C
POWER RATING	Input Power	1W

Ordering Code



CPM601-P

One Device for a wide range of assets and testing applications



Rugged Monitoring presents most advanced Partial Discharge Monitor CPM601 to perform PD measurements in dual frequency range i.e., in the range of 0.01MHz - 100MHz as well as 300MHz - 2GHz.

With the help of advanced electronics embedded inside CPM601, user can perform PD measurement using various sensors without the need of using external frequency down converters. This presents All-in-One solution to perform PD measurements using Acoustic, Ultrasonic, HFCT, TEV, Coupling Capacitors as well as UHF Sensors on all assets, GIS, Power Transformers, Rotating Machines and Power Cables.

CPM 601 is a Compact and sturdy enclosure with electronics making it portable, easy to carry, while enabling the user to perform PD measurements with less hassle. Monitor can directly transfer the data to PD Connect software installed on laptop else data can be temporarily stored (optional) in the device enabling the user to record PD pulses with higher sampling rate. Thousands of pulses per second can be transferred to the laptop enabling the user to generate fast and reliable Phase Resolved Partial Discharge (PRPD) graphs. PRPD patterns help the user to identify type of PD. CPM 601 and Software are packed with all necessary tools that help to perform effective PD measurements. Integrated variable amplifiers and onboard denoising features help during onsite testing in case of any huge noise.

We at Rugged Monitoring have a dedicated team for application specific customizations for sensors, monitor configuration and software integration to simplify data collection of testing and monitoring applications.

Applications

- Online periodic partial discharge monitoring
- Online PD measurement during HV AC testing (Resonant test set, VLF, OWTS)
- Multiple point PD monitoring
- Cables and their accessories
- Rotating machines
- AIS/GIS switchgear/switchboards
- Power transformers

Features

- Rugged, compact design
- Dual Frequency Ranges; 0.01MHz - 100MHz as well as 300MHz - 2GHz
- Compatible with Acoustic, Ultrasonic, HFCT, TEV, Coupling Capacitors as wells as UHF Sensors
- An interactive and comprehensive software PD Connect for reliable PD measurement and analysis
- Gigabit ethernet copper Cat5e communication link between monitor and laptop
- Optional rugged laptop with installed software suite
- IP65 rated

Benefits

- Rugged sensors, monitor and laptop
- Gigabit ethernet communication between monitor and laptop
- Enhanced noise rejection
- Realtime denoising
- Software packed with useful tools for reliable and interactive PD measurements
- Robust recording and analytics
- Customizable according to customer specific applications
- Suitable for Online PD measurements

Technical Specifications

INPUT CHANNELS	Channels	8 Multiplexed (4x HF and 4x UHF)
	Sampling Rate	250 MS/s
	Amplification	up to 50 dB, software selectable
	Filtering	Software configurable band pass filters
HF CHANNELS	Bandwidth	0.01 - 100 MHz
	Sensitivity	-50dBm
	Dynamic Range	50dB
UHF CHANNELS	Bandwidth	300 MHz - 2 GHz
	Sensitivity	-80 dBm
	Dynamic Range	70 Db
DATA TRANSFER	High Resolution (pulses data on simultaneous channels)	10,000 pulses per second for 4 simultaneous channels
	Low Resolution (pulse amplitude on simultaneous channels)	50,000 pulses per second for 4 simultaneous channels
	Transfer Rate	400 Mbps (depending on operating system and connection)
MEMORY	SSD	up to 1 TB (Optional)
COMMUNICATION LINK	Type	Ethernet Copper
	Cable	Cat5e
SYNCHRONISATION INPUTS	2 Inputs, software	Internal
	External	selectable
IP RATING	IP 65	
TEMPERATURE RATING	Ambient	-30°C - 60°C
	Storage	-40°C - 85°C
POWER RATING	Input Power	45 W
DIMENSIONS	260mm(L)x310mm(W)x120mm(H)	
LAPTOP	Rugged Laptop	(Optional)

Ordering Code

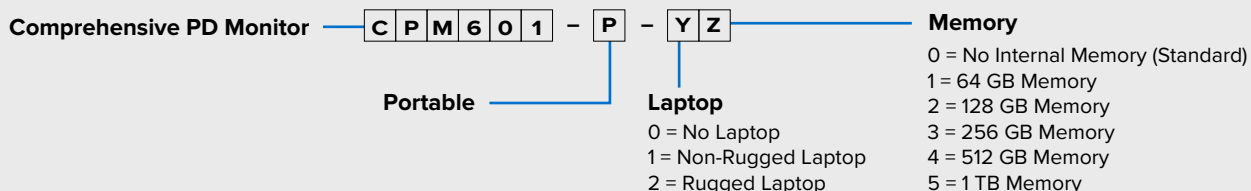

HPM601-C High Frequency Partial Discharge Monitor



"Rugged Monitoring High Frequency Partial Discharge (PD) monitoring solution is a platform that enables HV asset owners to keep monitoring PD round the clock due to insulation defects.

System can also be used to perform online PD measurement during HV AC testing. Solution can communicate with its user over IEC61850 or using Rugged Monitoring proprietary Rugged Enterprise software suite. Shielded monitor with small dimensions make it easy to get installed and start.

Enhanced and newly added hardware and software features ensure highly sensitive multi-channel PD measurements for reliable, industry-standard PD testing on a variety of electrical equipment and components. System simple design enables it to get interfaced to third party protocols. Thousands of pulses per second can be transferred to the Server enabling the user to generate fast and reliable Phase Resolved Partial Discharge (PRPD) graphs. PRPD graphs help the user to identify type of PD in HV assets. Monitoring solution is packed with all necessary tools that help to perform effective PD measurements. Integrated variable amplifiers and on-board noise suppression features help during onsite testing even in case of presence of huge noise.

Rugged Monitoring's team of experienced condition monitoring specialists provide innovative testing, Diagnosis and Customized Monitoring Solutions.

Applications

- Online PD measurement during HV AC testing (Resonant test set, VLF, OWTS)
- Multiple point PD monitoring
- Cables and their accessories
- Rotating machines
- AIS/GIS switchgear/switchboards
- Power transformers

Features

- Rugged, simple design
- 4 synchronous input channels allow 3 phase synchronous measurement with additional external synchronous channel to enable the use of other type of sensor
- Rugged Enterprise, a complete software suite for analyzing the data and generating reports
- Indicator LEDs to alert in case of PD alarm or warning
- Gigabit ethernet copper Cat5e or multimode fiber communication link between monitor and server

Benefits

- Highly Efficient sensors, monitor and server
- Gigabit ethernet communication between monitor and Server
- Robust design parameters
- Each device is tested rigorously
- Software packed with useful tools for reliable and interactive PD measurements
- Robust recording and analytics
- Customizable according to customer specific applications
- Suitable for Online PD measurements

Technical Specifications

MONITOR	Channels	4 simultaneous channels 8 & 12 channel options available with multiplexer
	Sampling Rate	250 MS/s
	Bandwidth	0.01-100 MHz
	Amplification	up to 28 dB, software selectable
	Filtering	Software configurable band pass filters
MEMORY	SSD	upto 256 GB (Optional)
DATA TRANSFER	High Resolution (Pulses data on simultaneous channels)	10,000 pulses per second for 4 simultaneous channels
	Low Resolution (Pulse amplitude on simultaneous channels)	50,000 pulses per second for 4 simultaneous channels
	Transfer Rate	400 Mbps (depending on operating system and connection)
REMOTE COMMUNICATION	IEC61850 (Optional)	
	Proprietary Rugged Connect for remote communication	
	Customized third party interface on request	
COMMUNICATION LINK	Type	Ethernet Fiber / Copper
	Cable Multimode	Fiber / Cat5e
	IP Rating	IP65
TEMPERATURE RATING	Ambient	-30°C - 60°C
	Storage	-40°C - 85°C
POWER RATING	Input Power	35 W max
SYNCHRONISATION INPUTS	2 Inputs, software	Internal
	Selectable	External
DIMENSIONS	260mm(L)x310mm(W)x120mm(H)	
SOFTWARE	Rugged Enterprise	

Ordering Code

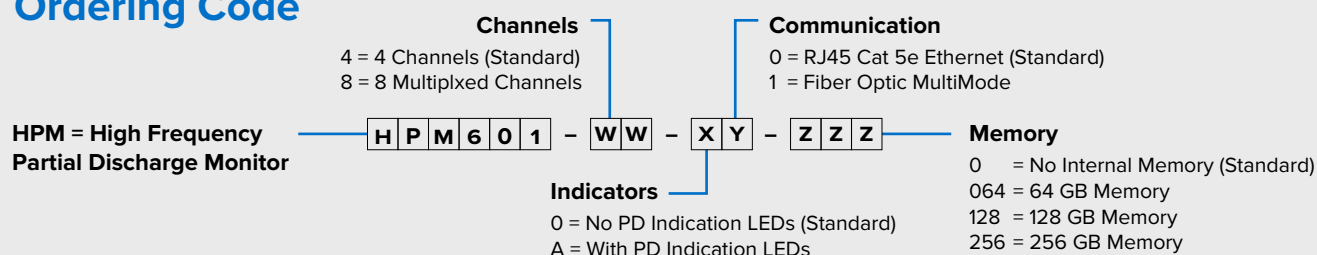

HPM601-P High Frequency Partial Discharge Monitor



Rugged design, designed for reliability, 3 Phase synchronous partial discharge monitoring equipment.

Rugged Monitoring High Frequency Partial Discharge (PD) Portable Monitor is a compact and rugged device enabling the user to perform periodic offline and online PD measurements in power cables and accessories, switchgears and rotating machines. Compact size and rugged enclosure and electronics make it portable, easy to carry and enabling the user to perform PD measurements with less hassle.

Monitor is capable of transferring the data directly to Rugged Enterprise software installed on laptop or data can be temporarily stored (optional) in the device enabling the user to record PD pulses with higher sampling rate. Thousands of pulses per second can be transferred to the laptop enabling the user to generate fast and reliable Phase Resolved Partial Discharge (PRPD) graphs. PRPD patterns help the user to identify type of PD. Monitor and Software are packed with all necessary tools that help to perform effective PD measurements. Integrated variable amplifiers and on board denoising features help during onsite testing in case of presence of huge noise.

There is a dedicated team for application specific customizations for sensors, monitor configuration and software integration to simplify data collection of testing and monitoring applications.

Applications

- Online periodic partial discharge monitoring
- Offline PD measurement during HV AC testing (Resonant test set, VLF, OWTS)
- Multiple point PD monitoring
- Cables and their accessories
- Rotating machines
- AIS/GIS switchgear/switchboards
- Power transformers

Features

- Rugged, compact design
- 4 synchronous input channels allow 3 phase synchronous measurement with additional external synchronous channel to enable the use of other type of sensor
- An interactive and comprehensive software Rugged Enterprise for reliable PD measurement and analysis
- Gigabit ethernet copper Cat5e communication link between monitor and laptop
- Optional rugged laptop with installed software suite IP65 rated

Benefits

- Rugged sensors, monitor and laptop
- Gigabit ethernet communication between monitor and laptop
- Enhanced noise rejection
- Realtime denoising
- Software packed with useful tools for reliable and interactive PD measurements
- Robust recording and analytics
- Customizable according to customer specific applications
- Suitable for Online or Offline PD measurements

Technical Specifications

INPUT SIMULTANEOUS CHANNELS	Channels	4 simultaneous channels 8 & 12 channel options available with multiplexer
	Sampling Rate	250 MS/s
	Bandwidth	0.01-100 MHz
	Amplification	up to 28 dB, software selectable
	Filtering	Software configurable band pass filters
MEMORY	SSD	up to 1 TB (Optional)
DATA TRANSFER	High Resolution (Pulses data on simultaneous channels)	10,000 pulses per second for 4 simultaneous channels
	Low Resolution (Pulse amplitude on simultaneous channels)	50,000 pulses per second for 4 simultaneous channels
	Transfer Rate	400 Mbps (depending on operating system and connection)
COMMUNICATION LINK	Type	Ethernet Copper
	Cable	Cat5e
TEMPERATURE RATING	Ambient	-30°C - 60°C
	Storage	-40°C - 85°C
POWER RATING	Input Power	35 W
SYNCHRONISATION INPUTS	2 Inputs, software	Internal & xternal
	IP Rating	IP65
DIMENSIONS	260mm(L)x310mm(W)x120mm(H)	
SOFTWARE	Rugged Enterprise	

Ordering Code

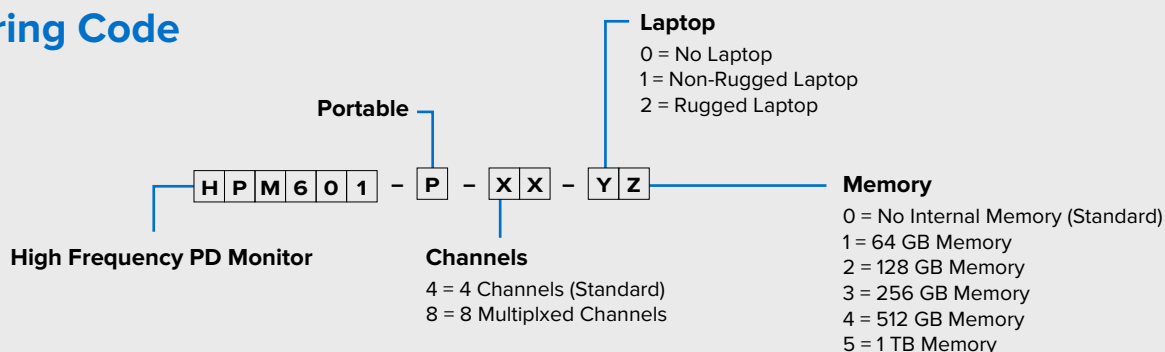

PD211

Rugged Partial Discharge Monitoring Module for OEMs



Rugged Monitoring PD211 is a compact design, designed for reliable Partial Discharge (PD) Monitoring Module for Transformers, Switchgears, GIS and Power Cable Terminations.

PD211 is based on the UHF (Ultra High Frequency) technology for PD signal acquisition and analysis. The Monitor is a combination of reliability and user-friendly configuration software. It has two variants with 04 channel and 08 channels, that can connect to 4 and 8 UHF-PD sensors respectively. The system can be integrated with any UHF PD sensors that are having response between 100MHz to 2000MHz.

The PD211 connects to the UHF PD sensors installed at the MV/HV assets. It measures the Ultra High Frequency (UHF) signals emitted by the PD Faults in HV/MV assets. The UHF signals are then analyzed for PD activity and categorization of Internal PD, External PD and Noise Signals. Internal PD signals are captured and stored for further analysis such as PRPD, PD Amplitude, Discharge Rate and trending. The PD amplitude and discharge rate is sent to the third-party system via Modbus (RTU) protocol using built-in serial (RS-485) port. The PRPD data is stored into the module and sent to third party system via CANBUS protocol using built-in CAN port.

Applications

- Online continuous partial discharge monitoring
- Online PD measurement during HV AC testing
- Multiple point PD monitoring
- PD monitoring in Transformer using UHF PD Sensors
- PD Monitoring in GIS using UHF PD Sensors
- PD Monitoring in MV Switchgear using UHF PD Sensors
- PD Monitoring in Power Cables Terminations UHF PD Sensors

Benefits

- Suitable for OEM-type applications (TMS, Gateways)
- Multiple mounting options - Din-Rail and Direct (Bare-board)
- Cost optimized solution for Partial Discharge monitoring
- Software designed for integration into monitoring systems /gateways
- Robust datalogging and Analytics
- Customizable according to customer specific applications
- Most accurate PD analysis with advanced noise gating
- Highly robust and safe monitoring systems

Technical Specifications

Number of Channels	04 or 08 (Simultaneous acquisition, No Multiplexing)
Sampling Rate	125 Ms/s
Acquisition Bandwidth	300Mhz - 2000Mhz
Vertical Resolution	12-Bit
PD Sensitivity	-80dBm
Noise Elimination	
- Bad Pass Filters	Tuneable for different frequencies including but not limited to 440Mhz, 800Mhz, 1100Mhz, and 1600Mhz
- Software Noise Gating	Advanced denoising algorithms
Data Storage (Memory)	MicroSD external memory slot (Up to 2 TB)
Compatible PD Sensors	Any Ultra High Frequency (UHF) PD Sensors with sensitivity 100Mhz - 2000MHZ.
Synchronization Inputs	2 Inputs (Internal and External)
Serial Port	RS-485 with Modbus RTU and Can Port with CANBUS protocol
Configuration Port	Ethernet Port for configuration
Operating Temperature	-30 to 75 °C
Storage Temperature	-40 to 85 °C
Dimensions	4.92" x 4.92" x 1.89" (125mm x 125mm x 48mm)
Humidity	95% Non Condensing
Power Input	12 - 24V DC (Default)
Power Consumption	15W
# of Relays Outputs	01 x Fail Safe Relay for System Failure

Ordering Code

Number of Channels
 04 = 4 Channels;
 08 = 8 Channels

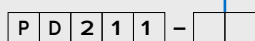

Memory

- 0 = No Internal Memory
- 1 = for 64GB Memory
- 2 = for 128GB Memory
- 3 = for 256GB Memory
- 4 = for 512GB Memory

PD201

Rugged Partial Discharge Monitoring Module for OEMs



The Rugged Monitoring PD201 is a compact design, designed for reliability Partial Discharge (PD) Monitoring Module for Transformers, Switchgears, Power Cables and Rotating Machines.

PD201 combines accuracy and easy to use software. It has two variants, 04 channel and 08 channels, that can connect to 4 and 8 PD sensors respectively. The system can be integrated with wide range of PD sensors such as HFCT, TEV, Bushing Adaptors, Capacitive Couplers, Acoustic, and Ultrasonic PD sensors.

The PD201 connects to the HF PD sensors installed at the MV/HV assets. It measures the High Frequency (HF) signals emitted by the PD Faults in HV/MV assets. The HF signals are then analyzed for PD activity and Module categorizes pulses as Internal PD, External PD and Noise Signals. Internal PD signals are captured and stored for further analysis such as PRPD, PD Amplitude, Discharge Rate and trending. The PD amplitude and discharge rate is sent to the third-party system via Modbus (RTU) protocol using built-in serial (RS-485) port. The PRPD data is stored in the module and sent to third party system via CANBUS protocol using built-in CAN port.

Applications

- Online continuous partial discharge monitoring
- Online PD measurement during HV AC testing
- Multiple point PD monitoring
- PD Monitoring in Transformer using Bushing
- Adaptors/Sensors
- PD Monitoring in Dry Type Transformers
- PD Monitoring in MV Switchgear using TEV / HFCT
- PD Monitoring in Power Cables using HFCT
- PD Monitoring in Generators and Motors using
- Capacitive Couplers and HFCT

Features

- Rugged, Compact Design with multiple mounting options - Din-Rail, Direct
- 4 or 8 Synchronous Input Channels for monitoring Partial Discharge
- Monitors Partial Discharge into the Insulation of MV/HV assets
- Best in class EMI, ESD Immunity
- Modbus (Serial-RS485) and Canbus integration with third party systems
- Advance noise gating with built-in filters and software algorithms
- Built-In Fail Safe Relay for System Failure

Benefits

- Suitable for OEM-type applications (TMS, Gateways)
- Multiple mounting options - Din-Rail and Direct (Bare-board)
- Cost optimized solution for Partial Discharge monitoring
- Software designed for integration into monitoring systems / gateways
- Robust datalogging and Analytics
- Customizable according to customer specific applications
- Most accurate PD analysis with advanced noise gating
- Highly robust and safe monitoring systems

Technical Specifications

Number of Channels	04 or 08 (Simultaneous acquisition, No Multiplexing)
Sampling Rate	100 MS/s per channel
Acquisition Bandwidth	0.01 - 100Mhz
Vertical Resolution	12-Bit
Noise Elimination	
- Bad Pass Filters	User selectable integrated filters with 5Mhz to 25Mhz bandwidth range
- Software Noise Gating	Advanced denoising algorithms
Data Storage (Memory)	MicroSD external memory slot (Up to 2 TB)
Compatible PD Sensors	Any High Frequency (HF) PD Sensors (Bushing Adaptors, HFCT, TEV, Capacitive Couplers, Acoustic, Ultrasonic etc.)
Synchronization Inputs	2 Inputs (Internal and External)
Serial Port	RS-485 with Modbus RTU and Can Port with CANBUS protocol
Configuration Port	Ethernet Port for configuration
Operating Temperature	-30 to 75 °C
Storage Temperature	-40 to 85 °C
Dimensions	4.92" x 4.92" x 1.89" (125mm x 125mm x 48mm)
Humidity	95% Non Condensing
Power Input	12 - 24V DC (Default)
Power Consumption	15W
# of Relays Outputs	01 x Fail Safe Relay for System Failure

Ordering Code

Number of Channels
04 = 4 Channels;
08 = 8 Channels

P D 2 0 1 - [] []

[M] x [] **Memory**

0 = No Internal Memory
1 = for 64GB Memory
2 = for 128GB Memory
3 = for 256GB Memory
4 = for 512GB Memory

R501 Rack Mount Comprehensive and Customizable Transformer Monitoring Solution



Most Versatile, Multi Channel, Comprehensive Transformer Monitoring Solution

Single Monitoring Solution for: Temperature, Partial Discharge, Bushing, Load, Power, Losses and more...

Key Features

- Fully flexible rack mount and distributed architecture support
- Expandable to add different analog and (or) digital inputs and outputs
- Best in class EMI, ESD Immunity; range of communication options and protocol support
- Range of communication options for third party system integration
- Complies with the latest IEC/IEEE standards for Emission, Immunity, Safety and Environment.

Benefit

- Improved reliability
- Accurate predictive analysis
- Access asset data from anywhere
- One monitoring solution for various parameters
- Increased lifetime
- Highest Return on Investment
- Field upgradable with no device downtime



Sensors that can be connected to R501

1. OTI,WTI, RTD, PRD, Breather, Buchholz Relay, LLG/OLI, Pressure Sensor etc.
2. Direct winding Hot Spot Monitor
3. Cooling System and Control Cabinet
4. Dissolved Gas Analyzer
5. Bushing Monitoring
6. Partial Discharge Monitor

Product Drawing

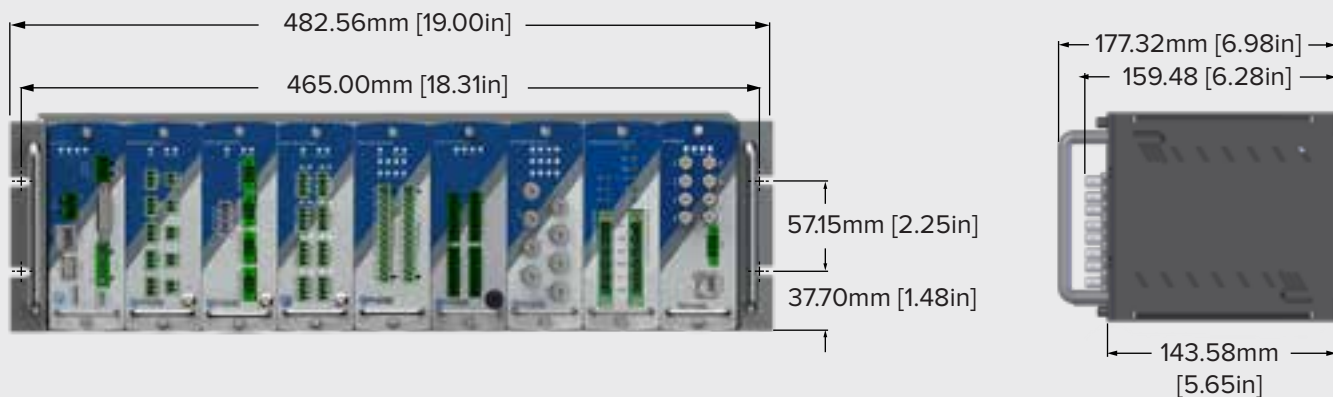

Weight : 5 Kilograms

Optional Smaller 3U Chassis

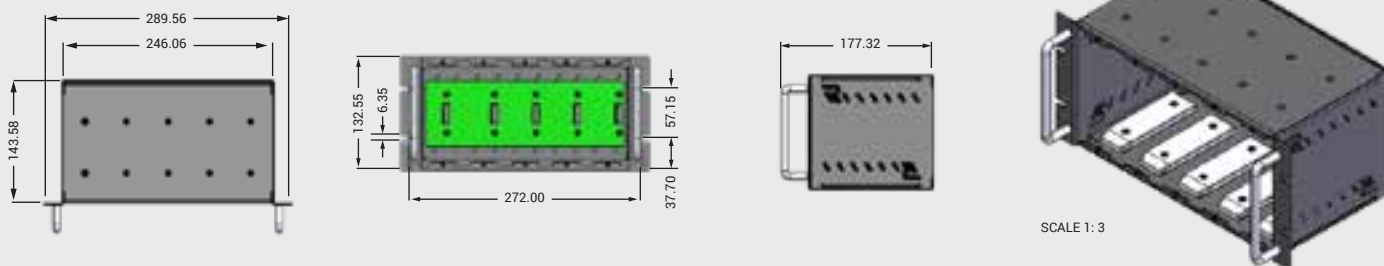

Ordering Code

Contact our sales team for Ordering Code

**One Solution for Multi-Site
Multi Asset Monitoring**



R501 Monitoring Modules

Comprehensive Features to Meet Market Demand

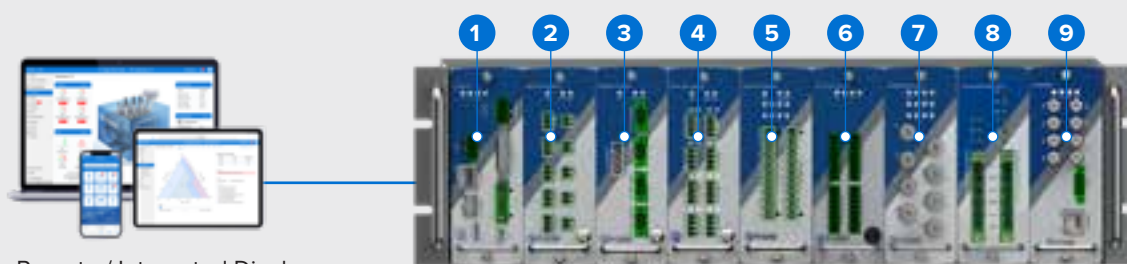

Remote / Integrated Display

1. CPU/GTW Module



Option A. CPU Module

- Data Processing & Storage
- System Fault Relay
- 01 x Serial (RS485) ports
- 02 x Ethernet (PRP support)
- Health Assessment Analytics

Option B. CPU with GTW

- Main rack with CPU, Slave rack with GTW
- Provides power to all modules
- Up to 4 Racks can be daisy chained
- 01 x Serial (RS485) ports

Option C. GTW without CPU

- Main rack and slave racks with GTW
- Provides power to all modules
- Supports FOM and FLM modules
- Up to 4 Racks can be daisy chained
- 01 x Serial (RS485) ports

2. Analog Input Module



- 05 or 10 channels
- AC/DC current input
- RTD / Potentiometer
- Built-in LED indicators

3. Power Monitoring Module



- 03 Current & 03 Voltage Inputs
- Active, Reactive & Apparent Power
- Transformer Power Factor
- Through-Fault Monitoring (I2T)
- Current Signature Analysis
- OLTC Motor Torque

4. Digital Input Module



- 08 or 16 channels
- Input Voltage 75 - 250Vdc
- Threshold Voltage > 60V
- Built-in LED indicators

5. Relay Output Module



- 04 or 08 Form C Relays
- Dry contact (NO-C-NC)
- User Programmable
- Built-in LED indicators

6. Analog Output



- 08 or 16 Analog output
- DC Current Loop (4-20mA / 0-1mA)
- Dc Voltage (0-5V / 0-10V)
- User Programmable
- Built-in LED indicators

7. Fiber Optic Module



- 02, 04, 06 and 08 Channels
- GaAs (200u and 62.5u) Module
- Fluro Module
- Built-in LED indicators

8. Bushing Monitoring Module



- 03 or 06 Channels
- Leakage Current
- Tan Delta / Power Factor
- Capacitance
- Phase Voltage
- Custom Tap Adaptor for Different Bushing

9. Partial Discharge Module



HF

UHF

- 04 or 08 Channels Continuous Monitoring
- Wide Range (HF and UHF)
- Sampling 100 MS/s
- Vertical Resolution 12bit
- Advanced PD Analysis
- UHF, Acoustic, Bushing PD Sensors available

Technical Specifications

POWER SUPPLY	Input Power Requirement	24 Vdc (Default), Optional 48 Vdc, 125 Vdc, and any other (upon request)
CPU MODULE	Data Storage Capacity	MicroSD external memory slot (up to 2 TB)
	Logging Rate	1 sec interval on USB
	Config port	USB (to use with Rugged connect windows software)
SYSTEM CAPACITY	Maximum number of Channels	Expandable to 256 Channels, Daisy chain up to 32 units (with Modbus, Canbus)
FIBER OPTIC MODULES	# of Channels	2, 4, 6 and 8 channels
	Measurement Range	-80 °C to +300 °C (cryogenic 4 °K range optional)
	Resolution	0.1 °C
	Accuracy	±1.0 °C (±0.2 °C in relative temperature)
	Scan Rate	200 ms / channel (Optional: Faster scanning rates available)
ANALOG INPUT MODULE	# of Input Channels	05 or 10 Channels
	AC Current Input	Clamp-on CT with different ranges: 5Amp, 10Amp, 20Amp, 100Amp and others available
	DC Current Input	4 - 20 mA
	Temperature Input	100 ohm platinum (Pt100)
	Potentiometer	up to 20,000 ohms
POWER MONITORING MODULE	# of Input Channels	03 Current and 03 Voltage
	Current Input Range	0 - 5A
	Voltage Input Range	0 - 250V
	Sampling Rate	32 KS/s
	Measurement Parameters	Power, Through-Fault, Motor Torque etc.
DIGITAL INPUT MODULE	# of Input Channels	08 or 16 Channels
	Dry Contact	Resistance between the contact < 100 Ω
	Powered Contact	75 - 250Vdc
ANALOG OUTPUT MODULE	# of Input Channels	08 or 16 Channels
	Output format	4-20 mA or 0-5V or 0-10V Configurable for any measured / calculated value
BUSHING MONITORING MODULE	# of Input Channels	03 or 06 Channels
	Leakage Current Range	1mA to 200mA
	Monitoring Parameters	Tan Delta (PF), Capacitance, Phase Voltage
PARTIAL DISCHARGE MODULE	# of Input Channels	04 or 08 Channels
	Acquisition Bandwidth	HPM: 0.01 - 100Mhz UPM: 100 MHz - 2 GHz
	Monitoring Parameters	PD Amplitude, Discharge Rate and PRPD
OUTPUT RELAY MODULE	# of Output Channels	04 or 08 Form C relays

T401 Fiber Optic Temperature Monitors



Recommended for increased asset lifetime with highly reliable performance and reduced operational risks.

The Rugged Monitoring T401 is specifically designed for real time monitoring of electrical assets. The configurable T401 comes with a user-friendly monitor and software interface. With its advanced monitoring functions T401 can provide accurate measurements

for various electrical assets. The system offers complete immunity to RFI, EMI, Chemical, Microwave Radiations, and High Voltages, making it an optimal choice for environments where the limitations of conventional temperature sensors / monitors cannot be used in extreme conditions. It has the data integration capability to integrate with third party systems.

The T401 is designed to collect data and to easily integrate with existing systems through serial communication like RS-485/ SFP (Gigabit Optical Ethernet). The T401 monitor comes with Rugged Connect/RM EYE software which is designed to cater the needs of various commercial, industrial, and utility applications. It allows remote monitoring by sending alert to operators about fault conditions at an early stage and provides vital health information before any serious fault occurs.

We at Rugged Monitoring have a dedicated team for application specific customizations for sensors, monitor configuration and software integration to simplify data collection of testing and monitoring applications.

Features

- Expandable up to 8 channels
- No field calibration
- Plug and play connections
- Compact and rugged design
- Best in class EMI and ESD immunity
- Up to 8 programmable Form-C relays

Applications

- Oil filled transformers
- Dry type transformers
- Switchgears
- Cables
- Variable Frequency Drives
- Industrial Process Control and Monitoring

Benefits

- Avoid unplanned outages
- Reduced risk of catastrophic failure
- Increased asset lifetime
- Reduced Maintenance Costs
- Ensuring reliable operation

Technical Specifications

POWER SUPPLY	Input Power Requirement	24/48 VDC \pm 10%
	Power Consumption	20 Watts
ANALOG/DIGITAL INPUT MODULE	# of Input Channels	08/04 Channels
	Input Channel Types	Configurable from a range of input options, RTD, AC/DC current, AC/DC voltage, Potentiometer, Dry/Powered contact switch
	Accuracy of Channels	\pm 0.5% full scale input range
	Input Channel Sample Rate	1 Hz
ANALOG OUTPUT MODULE	# of Output Channels	04 Channels
	Output format	4-20 mA or 0-5Vdc / 0-10Vdc (Configurable for any measured / calculated value)
OUTPUT RELAY MODULE	# of Output Channels	08 Form C relays (5A)
	User Programmable	Yes, from Rugged Connect Software or webserver, if present
DATA STORAGE & CONFIGURATION	Data Storage Capacity	4 or 8 GB, Industrial Grade micro-SD, extendable to 2TB
	Logging Rate	User Configurable, 1 sec interval on USB
	System Fault Indication	1 System Fault Relay, with Local LED light
	Config port	USB (to use with Rugged connect windows software)
COMMUNICATION	Serial Communication	01 x RS-485 (RS-232 optional converter)
	Ethernet Communication	02 Ethernet Ports, configurable to RJ-45 or SFP (Gigabit Optical)
	Redundancy	Support PRP Redundancy
	Protocol Supported	Modbus, DNP3.0, IEC60870-104, IEC61850, Other protocols provided on request
EMC TYPE TESTING	Conducted & Radiated Emissions	ICES-003 (2016), CISPR32 (2015), CISPR11 (2015)
	ESD and EM Field Immunity	IEC61000-4-2, C37.90-3, IEC61000-4-3, C37.90.2v
	Fast Transient & Surge Immunity	IEC61000-4-4, IEC61000-4-5, C37.90.2
	Magnetic Field Immunity	IEC61000-4-8, IEC61000-4-10
	Immunity from Conducted Disturbances	IEC61000-4-6, IEC61000-4-16
	Ripple, Dips & Damped Oscillatory	IEC61000-4-17, IEC61000-4-18, IEC61000-4-29
	Safety	IEC60255-26 and CE Certified
ENVIRONMENTAL AND MECHANICAL	Operating Temperature	-40 to 72 °C
	Operating Humidity	95% Non Condensing
	Storage Temperature	-40 to 85 °C
	Dimensions	W26.7 cm x H7.2 cm x D18.7 cm (10.5" x 2.8" x 7.4")
	Weight	App. 1.5 to 2.0 Kg. (based on number of configuration)

T401 FEATURES

Comprehensive Features to Meet Market Demand

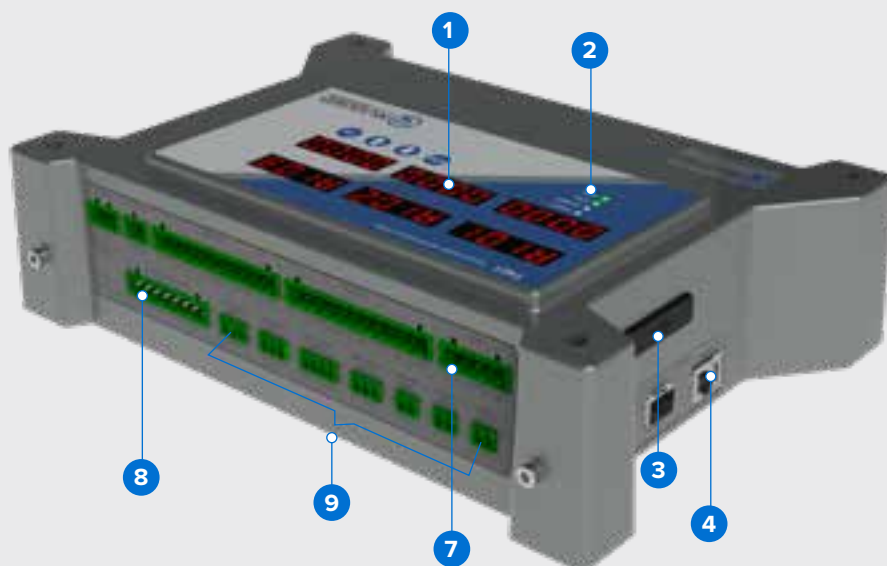

1. Local Display

- Industrial Grade LED
- Current Values of all Parameters

2. LED Indicators

- Power ON/OFF
- System Fault
- Alarm & Log

3. USB Port

- Configuration & Troubleshooting
- Data Export
- MicroSD Card

4. Ethernet Ports

- 02 x configurable Ports (RJ-45/SFP)
- Full Redundancy
- PRP Protocol
- Modbus, DNP3.0, IEC60870-104 and IEC 61850

5. Power Input

- 24 / 48 Vdc
- Power Supply Unit / Adaptor provided as Accessories (OPTIONAL)

6. Relay Outputs

- 08 x Form C Relay contacts
- NO-C-NC
- Cooling control
- Alerts / Alarms

7. Serial Port (Rs-485)

- Data Input/Output Integration
- Modbus Protocol
- DNP3.0 Protocol
- IEC60870-104 Protocol

9. Analog / Digital Inputs

- 08 x Configurable Inputs
- RTD (PT-100), Potentiometer
- AC Current (Clamp-On CT), DC current (4-20mA)
- Digital (Dry Contacts)
- AC/DC Voltage

8. Analog Outputs

- 04 x User Programmable
- Current Output (4-20mA)
- Voltage Output (0-5V/0-10V)



Rugged Software

- Desktop and Web Client
- Remote Configuration
- Advanced Visualization
- Data Logging, Reporting
- Supports Industry Standard Protocols
- Customization available on request
- Secure access to data & Configuration
- Multiple Language Support

Product Drawing

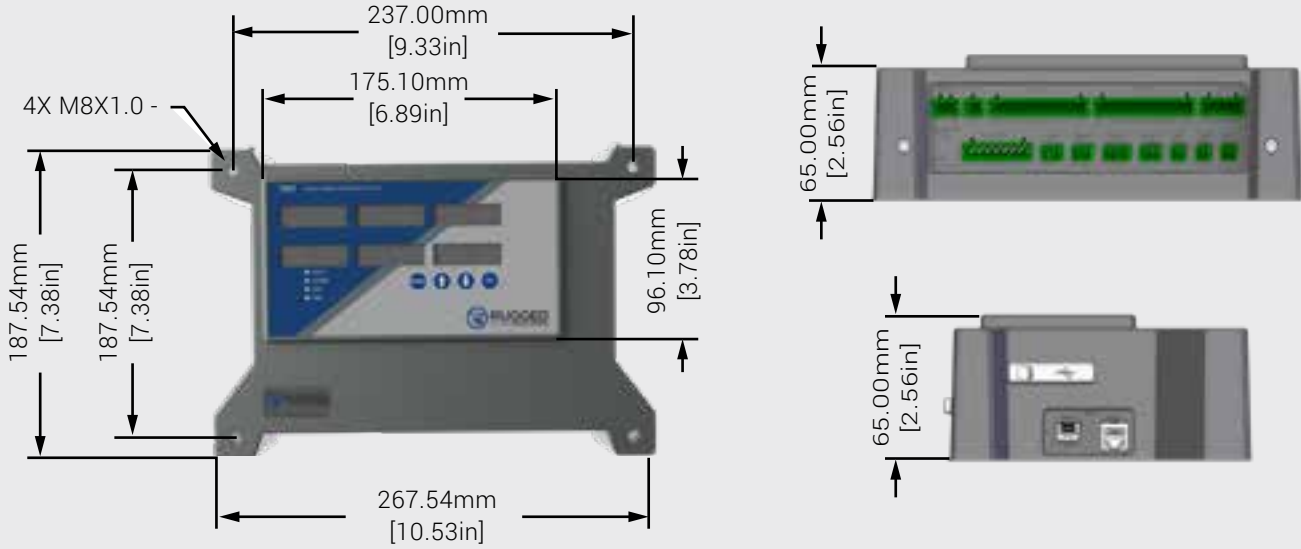

Weight : 2 Kilograms

Ordering Code

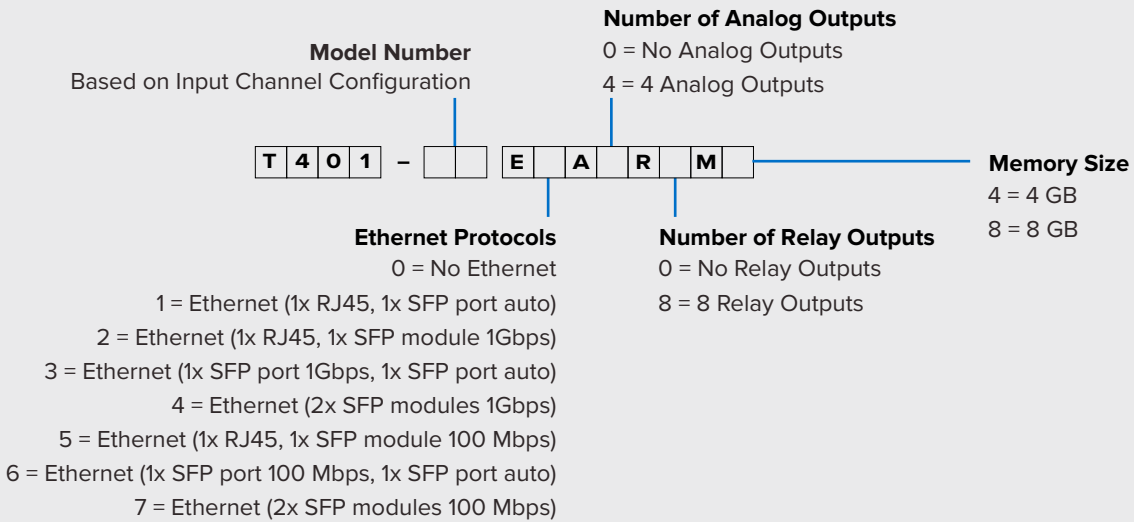

Features

- Multiple PD monitoring options to suit different site conditions
 - a) Ultra-High Frequency Method using USENS-D, USENS-T, USENS-TB, USENS-B, USENS-C, USENS-G, USENS-W
 - b) Electrical Method (IEC60270) using BSENS
 - c) High Frequency Method using HSENS-T, HSENS-H, HSENS-CC
 - d) Acoustic Method using ASENS
- Built-in Transient protection with Sensors and Monitors
- Rugged and reliable PD sensors
- Easy to install and commission
- Highly accurate measurement for PD activities
- Available for periodic and continuous monitoring
- Easy integration with third party Monitoring Devices/ SCADA/ Cloud
- Realtime PD Trends and PRPD analysis

Benefits

- Improved availability, Minimal or low equipment outages
- Reduced Risk, Avoid catastrophic failures of HV/MV assets
- Optimized asset maintenance and replacement planning
- Cost effective solution for various types of electrical assets
- Improved PD detection with Effective Noise gating

List of Products



R501

Most Versatile End to End monitoring system to get the most of your electrical assets.

Capable to accommodate various Monitoring Modules to cater specific requirement including **Partial Discharge Monitoring**.



T301

Fiber optic temperature monitor for accurate measurement of power transformer temperatures.



O201

Multichannel fiber optic temperature monitor for Industrial and Laboratory applications.



H201

Rugged, Compact Design for quick temperature reading and testing.



T501

Real Time Monitoring and Advance Control.

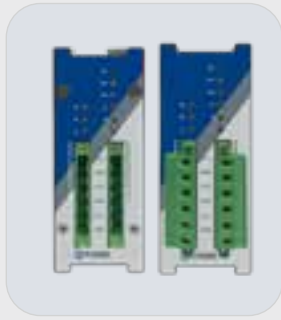

BM201

Advanced and Simple Bushing Monitoring integration features for OEM's.

List of Other Accessories

C5M Paint

Atmospheric corrosivity and special corrosion stresses influence the durability of the structure's corrosion protection painting and the planning of paint work in an important way. C5M paint is used in outdoor applications in coastal areas and offshore area with aggressive atmosphere and high salt concentrations. For selection there are different systems such as Medium (5-15 years), High (>15 years) and Extreme (25 years). The classification is based on the corrosion rate of steel and zinc during the first year in exposure.

Coaxial Cables

High noise immunity Coaxial cables are used as it allows to carry many channels simultaneously, eliminating the need for thousands of separate wires to be strung.

Recommended: RG58 or RG223 or RG213

Ethernet Cables

Designed to address long distance communication drawbacks RM uses customized cables with high flexibility and reliable communication to prevent any data distortion or errors.

Recommended: RJ45

Asset Monitoring : Enterprise Architecture

Compatible with Rugged Monitoring Enterprise Solution

UI UX



- Data Layer
- Analytics
- User Interface
- Custom Dashboards
- Reporting
- Email/SMS Notifications

RM EYE

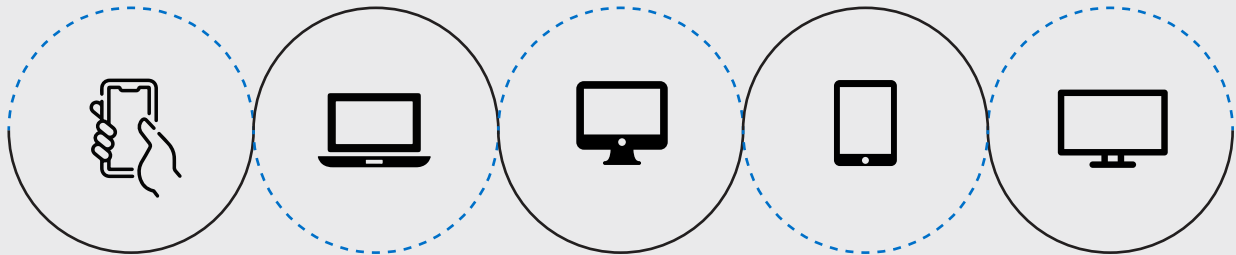

Private Cloud (Customer Cloud),
Rugged Monitoring Cloud

IEC 60870-104

IEC 61850

FTP/SFTP

- XML, JSON

- CSV, COMTRADE



Data Collection

ODBC

MODBUS

DNP 3.0

HTTPS

MQTT

Asset Data

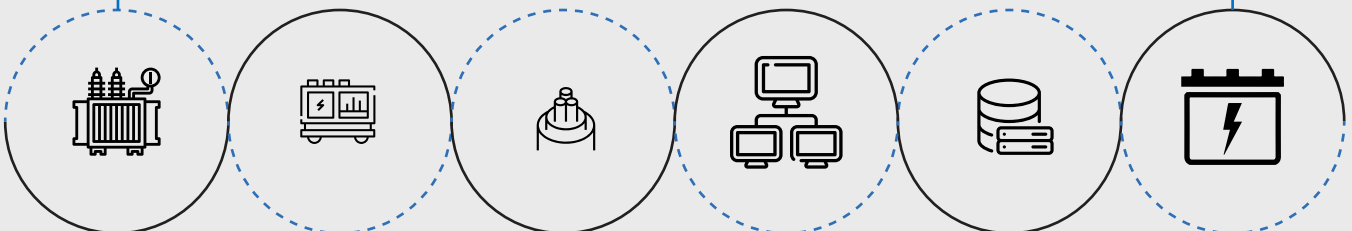

Transformer
Monitoring
System

Switchgear
Monitoring
System

Power Cable
Monitoring
System

- Offline Test Results
- Inspection Records
- Name Plate

- Historian
- CMMS
- SCADA/ DCS

Power Electronics
(Battery, UPS,
VFD, Relay)

One Solution for Multi-Site Multi Asset Monitoring

Manage different industrial assets on one platform without human intervention

Features

- **Advanced and Exceptional Reporting**
Technology with automated alerts
- **Modern remote monitoring solutions** provide valuable insights to Multiple Assets at Multiple Sites on real-time
- **Robust asset health monitoring** with analysis and recommendations support asset effectiveness in addition to maximizing equipment uptime
- **Establish a real time and consistent monitoring** by getting the right information into right hands
- **An efficient, reliable partial discharge monitoring** for all the assets
- **A detailed comprehensive DGA Analysis**
- **Lifetime Consumption details.**
- **Built on well-established remote and cloud-based monitoring technology**
- **Simple user-friendly interface** providing fast access to all the features and commands
- **Quick and easy 1 step configuration setup**
- **Encompasses a secure access to data and configuration**
- **Advanced asset algorithms** based on standard ones with new ideas
- **Systematic fleet management and analysis**
- **Extended multilingual support** to handle product inquires or troubleshoot problems proactively
- **Up System Level Reporting**
- **Industrial IoT**

Features Specific to PD Monitoring

- Partial Discharge monitoring and Analysis
- PRPD : Phase resolve partial discharge
- Partial Discharge Amplitude and Discharge rate trend analysis
- Partial Discharge Fault localization
- Artificial Intelligence based PD fault Identification
- Realtime PD Alarm system
- Get Alarm notifications for individual bushing parameters over Email, sms and push notifications
- Analytics on Online, and offline partial discharge test data

Why Customers Choose Us?

RM solution, the trusted monitoring solution for over 10000+ assets across 50+ countries. We are a leading High Value Electrical Asset Monitoring Company integrating fibre optic technology to the assets.



Attention to Details

It's our attention to the small stuff, scheduling of timelines and keen project management that makes us stand out from the rest.



A plan for Success

Our Customers are well satisfied with the advisory services that we offer to help them with best in class technological performance and a long durable life.



Experts only

We bring in our diversified experienced team with over 100+ years of experience in Asset Monitoring



Meeting Deadlines

Work with us, and you'll work with seasoned professionals – vigilant of deadlines, and committed to exceeding client expectations.



Money Matters

We protect you against currency fluctuation with competitive and fair market prices



Rugged Monitoring Services

Rugged Monitoring provides customization of sensors, monitors & software. In addition we offer on-site commissioning services, maintenance contracts and technical support to all customers worldwide.

About Rugged Monitoring

Industry's leading team of asset condition monitoring experts with 100+ years of combined experience committed to delivering customizable solutions for challenging applications. We offer a range of reliable, high performance, customizable sensors and monitoring solutions that are immune to external influence.

Certification



ISO 9000



ISO 14000



ISO 45001/
OHSAS 18000



Lloyd's
Register



ATEX
Certification

Our Presence Across the Globe



Head Office

 **Canada**

1415 Frank-Carrel, Suite
230, Quebec, QC - G1N
4N7, CANADA

 +1-418-767-0111

Asia Pasific | India | Europe | Latin America | Middle East | North America



 ruggedmon

 info@ruggedmonitoring.com

 www.ruggedmonitoring.com

©2021 Rugged Monitoring Company. All rights reserved. Information subject to change without notice. All trademarks are properties of their respective companies, as noted herein.